

PHILIPS

Signage Display

6000 Series

43BDL6017P

50BDL6017P

55BDL6017P



User Manual (English)

Table Of Contents

1.	Safety Instructions	1		
2.	Unpacking and Installation.....	8		
2.1.	Unpacking	8		
2.2.	Package Contents.....	10		
2.3.	Installation Notes	10		
2.4.	Mounting on a Wall	11		
2.4.1.	VESA Grid	11		
2.5.	Mounting in Portrait Orientation	12		
2.5.1.	How to remove the logo.....	12		
2.6.	Operating Instructions of Edge Alignment Kit.....	13		
2.6.1.	Installing the Edge Alignment Kit.....	13		
3.	Parts and Functions	14		
3.1.	Control Panel	14		
3.2.	Input/Output Terminals.....	15		
3.3.	Remote Control.....	16		
3.3.1.	General functions.....	16		
3.3.2.	ID Remote Control	17		
3.3.3.	Inserting the Batteries in the Remote Control.....	18		
3.3.4.	Handling the Remote Control.....	18		
3.3.5.	Operating range of the Remote Control.....	18		
3.4.	USB Cover	19		
3.5.	AC Switch Cover.....	19		
4.	Connecting External Equipment	20		
4.1.	Connecting External Equipment	20		
4.1.1.	Using HDMI video input.....	20		
4.2.	Connecting a PC.....	20		
4.2.1.	Using DVI input.....	20		
4.2.2.	Using HDMI input	20		
4.2.3.	Using DP input	21		
4.3.	Connecting Multiple Displays in a Daisy-Chain Configuration.....	21		
4.3.1.	Display control connection.....	21		
4.4.	IR connection.....	21		
4.5.	IR Pass-through Connection.....	22		
4.6.	Wire-Connecting to Network.....	22		
5.	Operation	23		
5.1.	Play multimedia files from USB device.....	23		
6.	OSD Menu	24		
6.1.	Navigating the OSD Menu	24		
6.1.1.	Navigating the OSD menu using the remote control.....	24		
6.1.2.	Navigating the OSD menu using the display's control buttons.....	24		
6.2.	OSD Menu Overview	24		
6.2.1.	Picture menu	24		
6.2.2.	Screen menu	25		
6.2.3.	Audio	26		
6.2.4.	Configuration1 menu	26		
6.2.5.	Configuration2 menu	27		
6.2.6.	Option	28		
7.	Supported Media Formats.....	32		
8.	Input Mode	33		
9.	Pixel Defect Policy	34		
9.1.	Pixels and Sub-Pixels.....	34		
9.2.	Types of Pixel Defects + Dot Definition.....	34		
9.3.	Bright Dot Defects.....	34		
9.4.	Dark Dot Defects	35		
9.5.	Proximity of Pixel Defects	35		
9.6.	Pixel Defect Tolerances	35		
9.7.	Mura.....	35		
10.	Cleaning and Troubleshooting	37		
10.1.	Cleaning	37		
10.2.	Troubleshooting	38		
11.	Technical Specifications.....	39		
	Warranty policy for Philips Professional Display Solutions	41		
	Index.....	43		

1. Safety Instructions

Safety precautions and maintenance



WARNING: Use of controls, adjustments or procedures other than those specified in this documentation may result in exposure to shock, electrical hazards and/or mechanical hazards.

Read and follow these instructions when connecting and using your display:

This product is intended for use in professional installations in business settings only and is not suitable for domestic purposes. Any use other than that for which this device is intended can void the warranty.

This product contains an operating system. If it is shut down directly using the AC switch, it may damage the program and prevent it from powering on again. If the system is unable to power on due to frequent shutdowns, please try a factory reset. Please note that all data stored in the system will be lost when the display is rebooted after a factory reset.

Operation:

- Keep the display out of direct sunlight and away from stoves or any other heat sources.
- Keep the display away from oil, otherwise the plastic cover may be damaged.
- It is recommended to set the display up in the well-ventilated place.
- Ultra-violet ray filter is necessary of outdoor operation.
- If the product will be used in extreme conditions such as high temperature, humidity, display patterns or operation time, etc. It is strongly recommended to contact Philips for Application engineering advice. Otherwise, its reliability and function may not be guaranteed. Extreme conditions are commonly found at Airports, Transit Stations, Banks, Stock market, and Controlling systems.
- Remove any object that could fall into ventilation holes or prevent proper cooling of the display's electronics.
- Do not block the ventilation holes on the cabinet.
- When positioning the display, make sure the power plug and outlet are easily accessible.
- When turning off the display by detaching the power cord, wait 6 seconds before re-attaching the power cord for normal operation.
- Ensure the use of an approved power cord provided by Philips at all times. If your power cord is missing, please contact your local service center.
- Do not subject the display to severe vibration or high impact conditions during operation.
- Do not knock or drop the display during operation or transportation.
- The eye bolt is for usage in short-time maintenance and installation. We suggest not to use the eye bolt for more than 1 hour. Prolong usage is prohibited. Please keep a clear safety area under the display while using the eye bolt.

Maintenance:

- To protect your display from possible damage, do not put excessive pressure on the LCD panel. When moving your display, grasp the frame to lift; do not lift the display by placing your hands or fingers on the LCD panel.
- Unplug the display if you are not going to use it for an extensive period of time.
- Unplug the display if you need to clean it with a slightly damp cloth. The screen may be wiped with a dry cloth when the power is off. However, never use organic solvent, such as, alcohol, or ammonia-based liquids to clean your display.
- To avoid the risk of shock or permanent damage to the set, do not expose the display to dust, rain, water or an excessively moist environment.
- If your display becomes wet, wipe it with dry cloth as soon as possible.
- If a foreign substance or water gets in your display, turn the power off immediately and disconnect the power cord. Then remove the foreign substance or water, and send the unit to the maintenance center.
- Do not store or use the display in locations exposed to heat, direct sunlight or extreme cold.
- In order to maintain the best performance of your display and ensure a longer lifetime, we strongly recommend using the display in a location that falls within the following temperature and humidity ranges.

Environmental absolute ratings

Item	Min.	Max.	Unit
Storage temperature	-20	65	°C
Operation temperature	0	40	°C
Glass Surface temperature (Operation)	0	65	°C
Storage humidity	5	90	% RH
Operating humidity	20	80	% RH

- LCD panel temperature need to be 25 degrees Celsius at all time for better luminance performance.
- Only the lifetime of the display stated in this specification is guaranteed if the display is used under the proper operation conditions.

IMPORTANT: Always activate a moving screen saver program when you leave your display unattended. Always activate a periodic screen refresh application if the unit will display unchanging static content. Uninterrupted display of still or static images over an extended period may cause “burn in”, also known as “after-imaging” or “ghost imaging”, on your screen. This is a well-known phenomenon in LCD panel technology. In most cases, the “burned in” or “after-imaging” or “ghost imaging” will disappear gradually over a period of time after the power has been switched off.

WARNING: Severe “burn-in” or “after-image” or “ghost image” symptoms will not disappear and cannot be repaired. This is also not covered under the terms of your warranty.

Service:

- The casing cover should be opened only by qualified service personnel.
- If there is any need for repair or integration, please contact your local service center.
- Do not leave your display under direct sunlight.



If your display does not operate normally, having followed the instructions set out in this document, please contact a technician or your local service center.

Stability Hazard.

The device may fall, causing serious personal injury or death. To prevent injury, this device must be securely attached to the floor/wall in accordance with the installation instructions.

Read and follow these instructions when connecting and using your display:

- Unplug the display if you are not going to use it for an extensive period of time.
- Unplug the display if you need to clean it with a slightly damp cloth. The screen may be wiped with a dry cloth when the power is off. However, never use alcohol, solvents or ammonia-based liquids.
- Consult a service technician if the display does not operate normally when you have followed the instructions in this manual.
- The casing cover should be opened only by qualified service personnel.
- Keep the display out of direct sunlight and away from stoves or any other heat sources.
- Remove any object that could fall into the vents or prevent proper cooling of the display's electronics.
- Do not block the ventilation holes on the cabinet.
- Keep the display dry. To avoid electric shock, do not expose it to rain or excessive moisture.
- When turning off the display by detaching the power cable or DC power cord, wait for 6 seconds before re-attaching the power cable or DC power cord for normal operation..
- To avoid the risk of shock or permanent damage to the set do not expose the display to rain or excessive moisture.
- When positioning the display, make sure the power plug and outlet are easily accessible.
- **IMPORTANT:** Always activate a screen saver program during your application. If a still image in high contrast remains on the screen for an extended period of time, it may leave an 'after-image' or 'ghost image' on the front of the screen. This is a well-known phenomenon that is caused by the shortcomings inherent in LCD technology. In most cases the afterimage will disappear gradually over a period of time after the power has been switched off. Be aware that the after-image symptom cannot be repaired and is not covered under warranty.
- If provided with a 3-pin attachment plug on the power cord, plug the cord into a grounded (earthed) 3-pin outlet. Do not disable the power cord grounding pin, for example, by attaching a 2-pin adapter. The grounding pin is an important safety feature.

EU Declaration of Conformity

This device complies with the requirements set out in the Council Directive on the Approximation of the Laws of the Member States relating to Electromagnetic Compatibility (2014/30/EU), Low-voltage Directive (2014/35/EU), RoHS directive (2011/65/EU), ESPR Regulation (EU) 2024/1781.

This product has been tested and found to comply with the harmonized standards for Information Technology Equipment, these harmonized standards published under Directives of Official Journal of the European Union.

ESD Warnings

When user close to the monitor may cause the equipment discharge and reboot to the display of main menu.

Federal Communications Commission (FCC) Notice (U.S. Only)

Note: This equipment has been tested and found to comply with the limits for a Class B digital device, pursuant to part 15 of the FCC Rules. These limits are designed to provide reasonable protection against harmful interference in a residential installation. This equipment generates, uses and can radiate radio frequency energy and, if not installed and used in accordance with the instructions, may cause harmful interference to radio communications. However, there is no guarantee that interference will not occur in a particular installation. If this equipment does cause harmful interference to radio or television reception, which can be determined by turning the equipment off and on, the user is encouraged to try to correct the interference by one or more of the following measures:

- Reorient or relocate the receiving antenna.
- Increase the separation between the equipment and receiver.
- Connect the equipment into an outlet on a circuit different from that to which the receiver is connected.
- Consult the dealer or an experienced radio/TV technician for help.

TPV USA Corp
6525 Carnegie Blvd #200
Charlotte, NC 28211
USA

Polish Center for Testing and Certification Notice

The equipment should draw power from a socket with an attached protection circuit (a three-prong socket). All equipment that works together (computer, display, printer, and so on) should have the same power supply source.

The phasing conductor of the room's electrical installation should have a reserve short-circuit protection device in the form of a fuse with a nominal value no larger than 16 amperes (A).

To completely switch off the equipment, the power supply cable must be removed from the power supply socket, which should be located near the equipment and easily accessible.

A protection mark "B" confirms that the equipment is in compliance with the protection usage requirements of standards PN-93/T-42107 and PN-89/E-06251.

Wymagania Polskiego Centrum Badań i Certyfikacji

Urządzenie powinno być zasilane z gniazda z przyłączonym obwodem ochronnym (gniazdo z kołkiem). Współpracujące ze sobą urządzenia (komputer, monitor, drukarka) powinny być zasilane z tego samego źródła.

Instalacja elektryczna pomieszczenia powinna zawierać w przewodzie fazowym rezerwową ochronę przed zwarciami, w postaci bezpiecznika o wartości znamionowej nie większej niż 16A (amperów).

W celu całkowitego wyłączenia urządzenia z sieci zasilania, należy wyjąć wtyczkę kabla zasilającego z gniazdka, które powinno znajdować się w pobliżu urządzenia i być łatwo dostępne.

Znak bezpieczeństwa "B" potwierdza zgodność urządzenia z wymaganiami bezpieczeństwa użytkowania zawartymi w PN-93/T-42107 i PN-89/E-06251.

Pozostałe instrukcje bezpieczeństwa

- Nie należy używać wtyczek adapterowych lub usuwać kołka obwodu ochronnego z wtyczki. Jeżeli konieczne jest użycie przedłużacza to należy użyć przedłużacza 3-żyłowego z prawidłowo połączonym przewodem ochronnym.
- System komputerowy należy zabezpieczyć przed nagłymi, chwilowymi wzrostami lub spadkami napięcia, używając eliminatora przepięć, urządzenia dopasowującego lub bezzakłóceniewego źródła zasilania.
- Należy upewnić się, aby nic nie leżało na kablach systemu komputerowego, oraz aby kable nie były umieszczone w miejscu, gdzie można byłoby na nie nadeptywać lub potykać się o nie.
- Nie należy rozlewać napojów ani innych płynów na system komputerowy.
- Nie należy wpychać żadnych przedmiotów do otworów systemu komputerowego, gdyż może to spowodować pożar lub porażenie prądem, poprzez zwarcie elementów wewnętrznych.
- System komputerowy powinien znajdować się z dala od grzejników i źródeł ciepła. Ponadto, nie należy blokować otworów wentylacyjnych. Należy unikać kładzenia luźnych papierów pod komputer oraz umieszczania komputera w ciasnym miejscu bez możliwości cyrkulacji powietrza wokół niego.

Electric, Magnetic and Electromagnetic Fields ("EMF")

1. We manufacture and sell many products targeted at consumers, which, like any electronic apparatus, in general, have the ability to emit and receive electromagnetic signals.
2. One of our leading Business Principles is to take all necessary health and safety measures for our products, to comply with all applicable legal requirements and to stay well within the EMF standards applicable at the time of producing the products.
3. We are committed to develop, produce and market products that cause no adverse health effects.
4. We confirm that if its products are handled properly for their intended use, they are safe to use according to scientific evidence available today.
5. We play an active role in the development of international EMF and safety standards, enabling us to anticipate further developments in standardization for early integration in its products.

Information for U.K. only

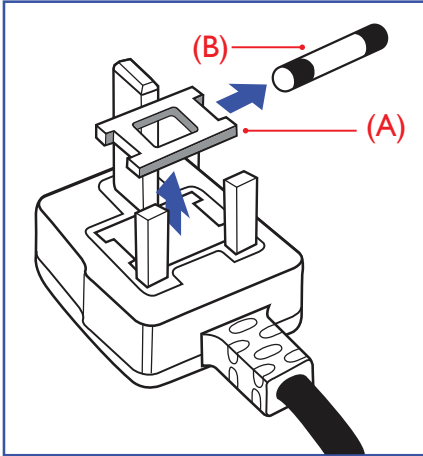

WARNING - THIS APPLIANCE MUST BE EARTHED.

Important:

This apparatus is supplied with an approved moulded 13A plug. To change a fuse in this type of plug proceed as follows:+

1. Remove fuse cover and fuse.
2. Fit new fuse which should be a BS 1362 5A, A.S.T.A. or BSI approved type.
3. Refit the fuse cover.

If the fitted plug is not suitable for your socket outlets, it should be cut off and an appropriate 3-pin plug fitted in its place.

If the mains plug contains a fuse, this should have a value of 5A. If a plug without a fuse is used, the fuse at the distribution board should not be greater than 5A.

NOTE: The severed plug must be destroyed to avoid a possible shock hazard should it be inserted into a 13A socket elsewhere.

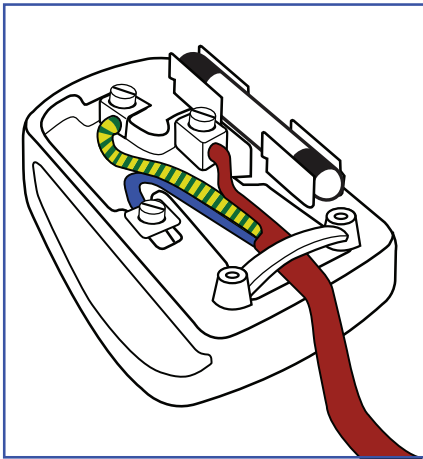

How to connect a plug

The wires in the mains lead are coloured in accordance with the following code:

BLUE - "NEUTRAL" ("N")

BROWN - "LIVE" ("L")

GREEN & YELLOW - "EARTH" ("E")

1. The GREEN & YELLOW wire must be connected to the terminal in the plug which is marked with the letter "E" or by the Earth symbol or coloured GREEN or GREEN & YELLOW.
2. The BLUE wire must be connected to the terminal which is marked with the letter "N" or coloured BLACK.
3. The BROWN wire must be connected to the terminal which marked with the letter "L" or coloured RED.

Before replacing the plug cover, make certain that the cord grip is clamped over the sheath of the lead - not simply over the three wires.

North Europe (Nordic Countries) Information

Placering/Ventilation

VARNING:

FÖRSÄKRA DIG OM ATT HUVUDBRYTARE OCH UTTAG ÄR LÄTÅTKOMLIGA, NÄR DU STÄLLER DIN UTRUSTNING PÅ PLATS.

Placering/Ventilation

ADVARSEL:

SØRG VED PLACERINGSFOR, AT NETLEDNINGENS STIK OG STIKKONTAKT ER NEMT TILGÆNGELIGE.

Paikka/Ilmankierto

VAROITUS:

SIIJOITA LAITE SITEN, ETTÄ VERKKOJOHTO VOIDAAN TARVITTAESSA HELPOSTI IRROTTAA PISTORASIESTA.

Plassering/Ventilasjon

ADVARSEL:

NÅR DETTE UTSTYRET PLOSSERES, MÅ DU PASSE PÅ AT KONTAKTENE FOR STØMTILFØRSEL ER LETTE Å NÅ.

Turkey RoHS:

Türkiye Cumhuriyeti: EEE Yönetmeliğine Uygundur

Ukraine RoHS:

Обладнання відповідає вимогам Технічного регламенту щодо обмеження використання деяких небезпечних речовин в електричному та електронному обладнанні, затвердженого постановою Кабінету Міністрів України від 3 грудня 2008 № 1057

End-of-Life Disposal

Your new Public Information Display contains materials that can be recycled and reused. Specialized companies can recycle your product to increase the amount of reusable materials and to minimize the amount to be disposed of.

Please find out about the local regulations on how to dispose of your old display from your local Philips dealer.

(For customers in Canada and U.S.A.)

This product may contain lead and/or mercury. Dispose of in accordance to local-state and federal regulations. For additional information on recycling contact www.eia.org (Consumer Education Initiative)

Waste Electrical and Electronic Equipment-WEEE**Attention users in European Union private households**

This marking on the product or on its packaging illustrates that, under European Directive 2012/19/EU governing used electrical and electronic appliances, this product may not be disposed of with normal household waste. You are responsible for disposal of this equipment through a designated waste electrical and electronic equipment collection. To determine the locations for dropping off such waste electrical and electronic, contact your local government office, the waste disposal organization that serves your household or the store at which you purchased the product.

Attention users in United States:

Please dispose of according to all Local, State and Federal Laws. For the disposal or recycling information, contact: www.mygreenelectronics.com or www.eiae.org.

End of Life Directives-Recycling

Your new Public Information Display contains several materials that can be recycled for new users.

Please dispose of according to all Local, State, and Federal laws.

ENERGY STAR is a program run by the U.S. Environmental Protection Agency (EPA) and U.S. Department of Energy (DOE) that promotes energy efficiency.



This product qualifies for ENERGY STAR in the "factory default" settings and this is the setting in which power savings will be achieved.

Changing the factory default picture settings or enabling other features will increase power consumption that could exceed the limits necessary to qualify for ENERGY STAR rating.

For more information on the ENERGY STAR program, refer to energystar.gov.

Restriction on Hazardous Substances statement (India)

This product complies with the "E-Waste (Management) Rules, 2016" CHAPTER V, rule 16, sub-rule (1) . Whereas New Electrical and Electronic Equipment and their components or consumables or parts or spares do not contain Lead, Mercury, Cadmium, Hexavalent Chromium, polybrominated biphenyls and polybrominated diphenyl ethers beyond a maximum concentration value of 0.1% by weight in homogenous materials for lead, mercury, hexavalent chromium, polybrominated biphenyls and polybrominated diphenyl ethers and of 0.01% by weight in homogenous materials for cadmium. except of exemptions set in Schedule 2 of the Rule.

E-Waste Declaration for India



This symbol on the product or on its packaging indicates that this product must not be disposed of with your other household waste. Instead it is your responsibility to dispose of your waste equipment by handing it over to a designated collection point for the recycling of waste electrical and electronic equipment. The separate collection and recycling of your waste equipment at the time of disposal will help to conserve natural resources and ensure that it is recycled in a manner that protects human health and the environment. For more information about E-waste please visit <http://www.india.philips.com/about/sustainability/recycling/index.page> and to know where you can drop off your waste equipment for recycling in India please contact on below given contact details.

Helpline number: 1800-425-6396 (Monday to Saturday, 9 a.m. to 5:30 pm)

E-mail: india.callcentre@tpv-tech.com

Batteries



For EU: The crossed-out wheeled bin implies that used batteries should not be put to the general household waste! There is a separate collection system for used batteries, to allow proper treatment and recycling in accordance with legislation.

Please contact your local authority for details on the collection and recycling schemes.

For Switzerland: The used battery is to be returned to the selling point.

For other non-EU countries: Please contact your local authority for correct method of disposal of the used battery. According to EU directive 2006/66/EC, the battery can't be disposed improperly. The battery shall be separated to collect by local service.

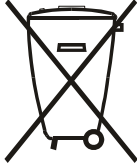

Após o uso, as pilhas e/ou baterias deverão ser entregues ao estabelecimento comercial ou rede de assistência técnica autorizada.

2. Unpacking and Installation

2.1. Unpacking

- This product is packed in a carton, together with the standard accessories.
- Any other optional accessories will be packed separately.
- As this product is high and heavy, the operation of moving the device is recommended to be performed by two technicians.
- After opening the carton, ensure that the contents are complete and in good condition.

■ Before Unpacking

- Please read and fully understand unpacking notice before installation.
- Please check the packing, there should be no any abnormality such as creak, dent mark, etc.
- Please do necessary inspection before you move the display out of the carton.
- Always install the display by experienced technician to prevent any damage.

■ Notice

- Take the display out of the carton box by two adults with both hands.
- Please do not grab or touch the glass of the display.
- Please grab on the bezel surface (plastic or metal) of the display.

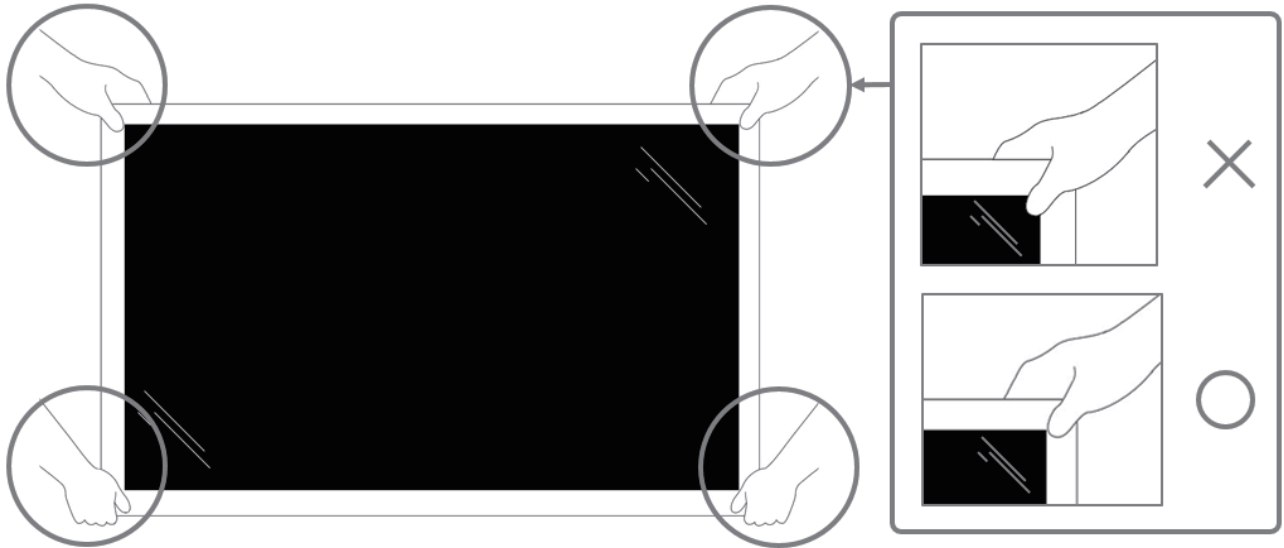

- Please keep the display vertically when moving it.

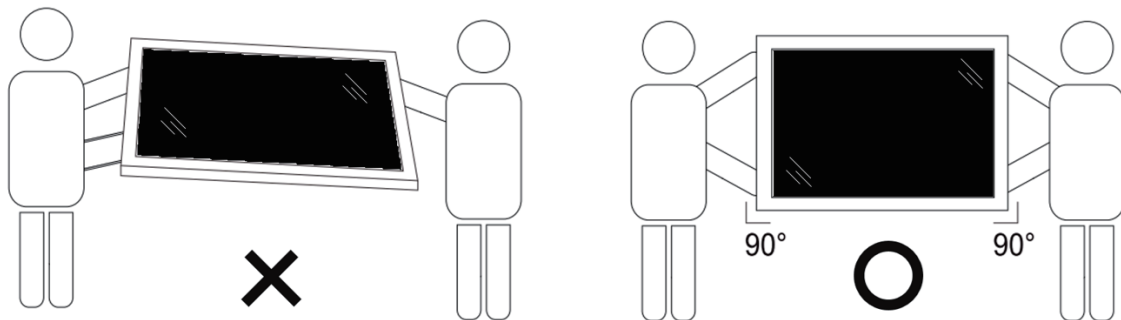

- Place the display vertically and its weight should spread evenly on the surface.

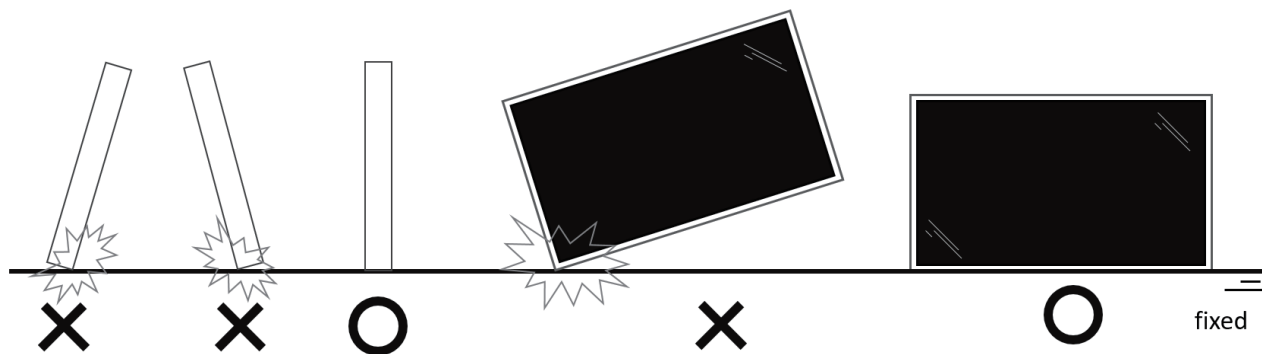

- Please keep vertically, no bending and torsion during moving the display.

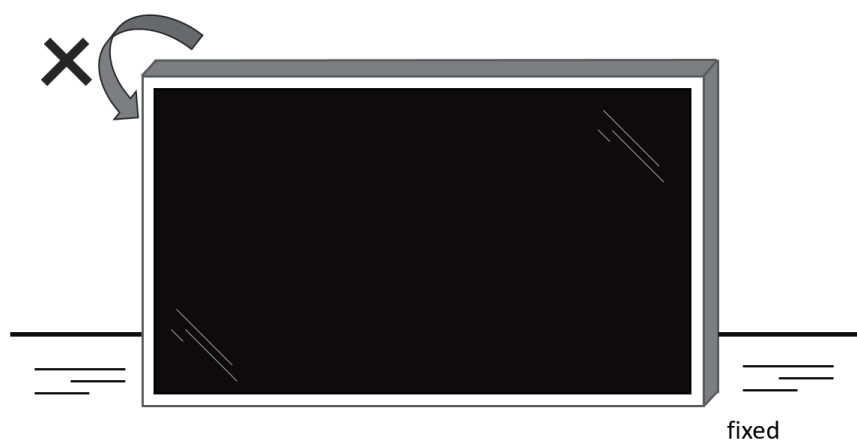

2.2. Package Contents

Please verify that you received the following items with your package content:

- LCD Display
- Remote Control and AAA Batteries
- Quick Start Guide
- Power Cord
- RS232 Cable
- RS232 Daisy Chain Cable
- Philips Logo Plate
- AC Switch Cover
- USB Cover
- Edge Alignment Kit-1
- Edge Alignment Kit-2 x 2
- OPS Cover

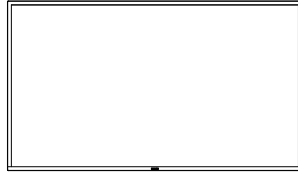

LCD Display

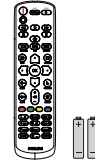

Remote Control and AAA Batteries



Quick Start Guide

* The supplied power cord varies depending on destination.



Power Cord

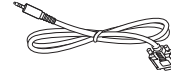

RS232 Cable

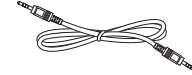

RS232 Daisy Chain Cable



Philips Logo Plate



AC Switch Cover



USB Cover



Edge Alignment Kit-1



Edge Alignment Kit-2 x 2



OPS Cover

* Differences according to regions.

Display design and accessories may differ from those illustrated above.

NOTES:

- For all other regions, apply a power cord that conforms to the AC voltage of the power socket and has been approved by and complies with the safety regulations of the particular country.
- You might like to save the package box and packing material for shipping the display.

2.3. Installation Notes

- Only use the power cable provided with this product. If an extension cord is required, please consult your service agent.
- The product should be installed on a flat surface, or the product may tip over. Leave a space between the rear of the product and the wall for proper ventilation. Do not install the product in a kitchen, bathroom or a place exposed to moisture, failure to do so may shorten the life of the internal parts.
- Do not install the product where it is 5000m and higher in altitude. Failure to do so may result in malfunctions.

2.4. Mounting on a Wall

To mount this display on a wall, a standard wall-mounting kit (commercially available) is required. It is recommended that you use a mounting interface that complies with TUV-GS and /or UL1678 standard in North America.

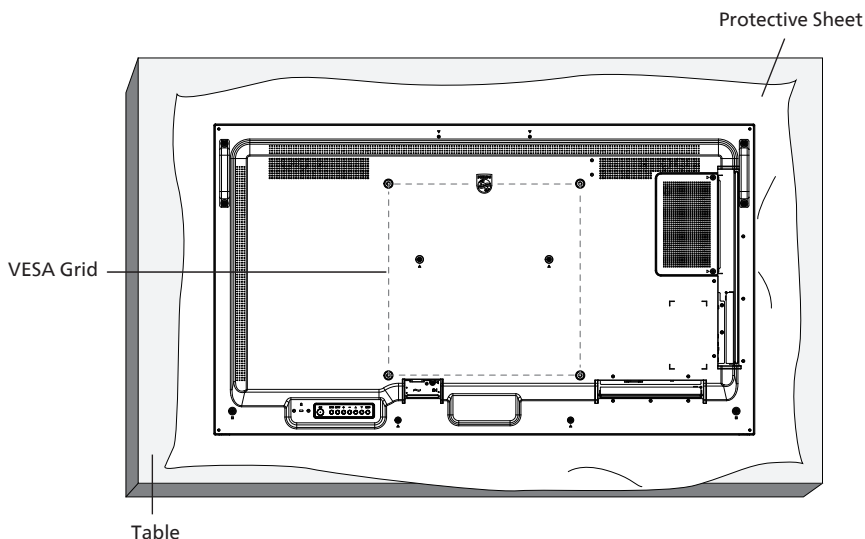

1. Spread a protective sheet which was wrapped around the display when it was packed on a flat surface. Lay the display face-down on the protective sheet to facilitate your operation without scratching the screen.
2. Ensure that you have all accessories necessary for any type of mounting (wall-mounting, ceiling mounting etc).
3. Follow the instructions that come with the base mounting kit. Failure to follow correct mounting procedures could result in damage to the equipment or injury to the user or installer. Product warranty does not cover damage caused by improper installation.
4. For the wall-mounting kit, use M6 mounting screws (43BDL6017P with a length of 14.5 mm longer than the thickness of the mounting bracket, 50BDL6017P/55BDL6017P with a length of 12.2 mm longer than the thickness of the mounting bracket) and tighten them securely.

2.4.1. VESA Grid

43BDL6017P	200(H) x 200(V) mm
50BDL6017P	400(H) x 400(V) mm
55BDL6017P	400(H) x 400(V) mm

Caution:

To prevent the display from falling:

- For wall or ceiling mounting, we recommend that you install the display with metal brackets which are commercially available. For detailed instructions about the installation, refer to the guide that comes with the bracket.
- To prevent the display from falling in case of earthquake or other natural disaster, please contact the manufacturer of the bracket for the mounting location.

Required space for ventilation

Leave a space of 100 mm at the top, rear, right and left for ventilation.

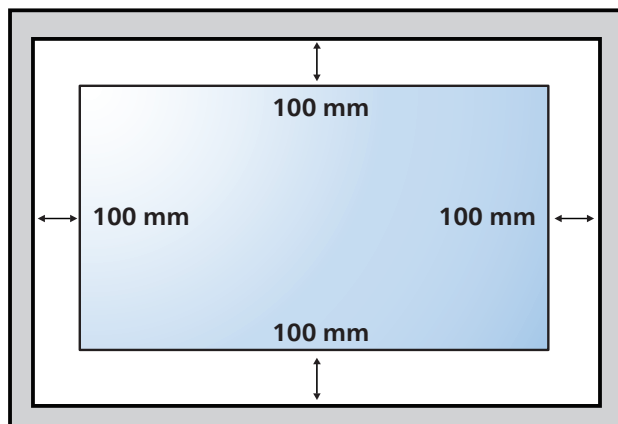

2.5. Mounting in Portrait Orientation

This display can be installed in portrait orientation.

Rotate the display 90 degrees counterclockwise. The **"PHILIPS"** logo should be on the right side when facing the display.

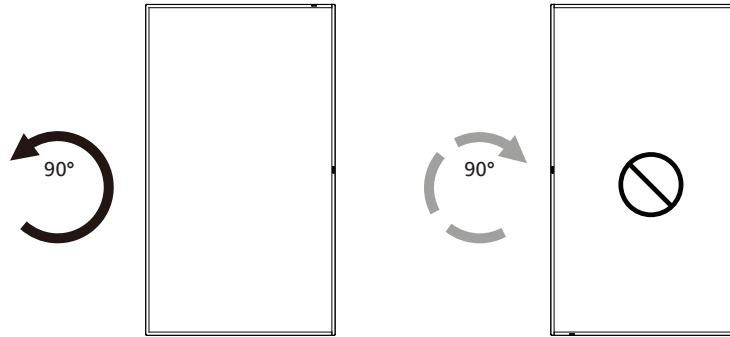

2.5.1. How to remove the logo

1. Prepare a piece of paper with a cutting area of logo as a protector to prevent the front bezel from scratching.
2. Use a knife and carefully remove the logo sticker with the paper placing beneath.
3. Tear off the logo sticker.

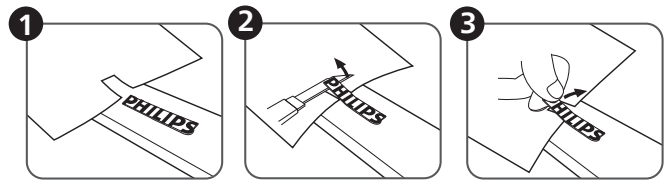

NOTE: We recommend that you contact a professional technician when installing the display on a wall. We are not responsible for any damage to the product if the installation is not performed by a professional technician.

2.6. Operating Instructions of Edge Alignment Kit

2.6.1. Installing the Edge Alignment Kit

Before installing the edge alignment kit, the display must be mounted to the video wall frame correctly.

- Use the thumb screws for easy mounting.
- Use the "Edge Alignment Kit-1" on 4 adjacent displays.

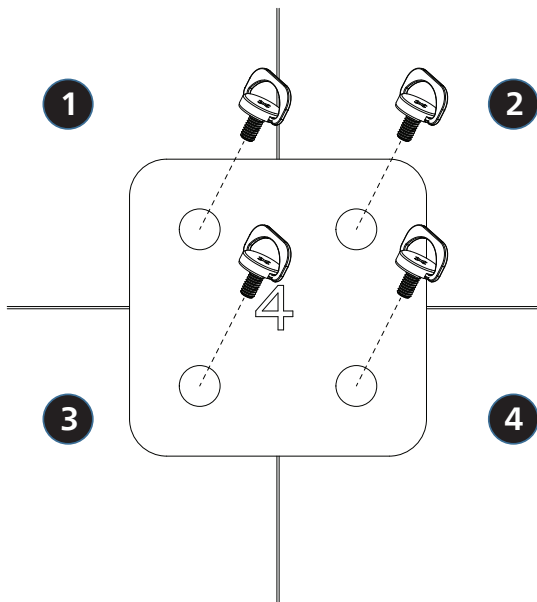

- Use the "Edge Alignment Kit -2" on 2 adjacent displays.

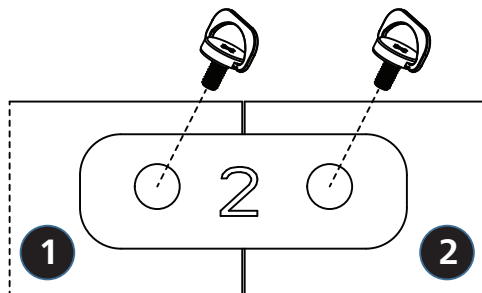

NOTE: When installing the edge alignment kit, please consult a professional technician for proper installation. We accept no liability for installations not performed by a professional technician.

3. Parts and Functions

3.1. Control Panel

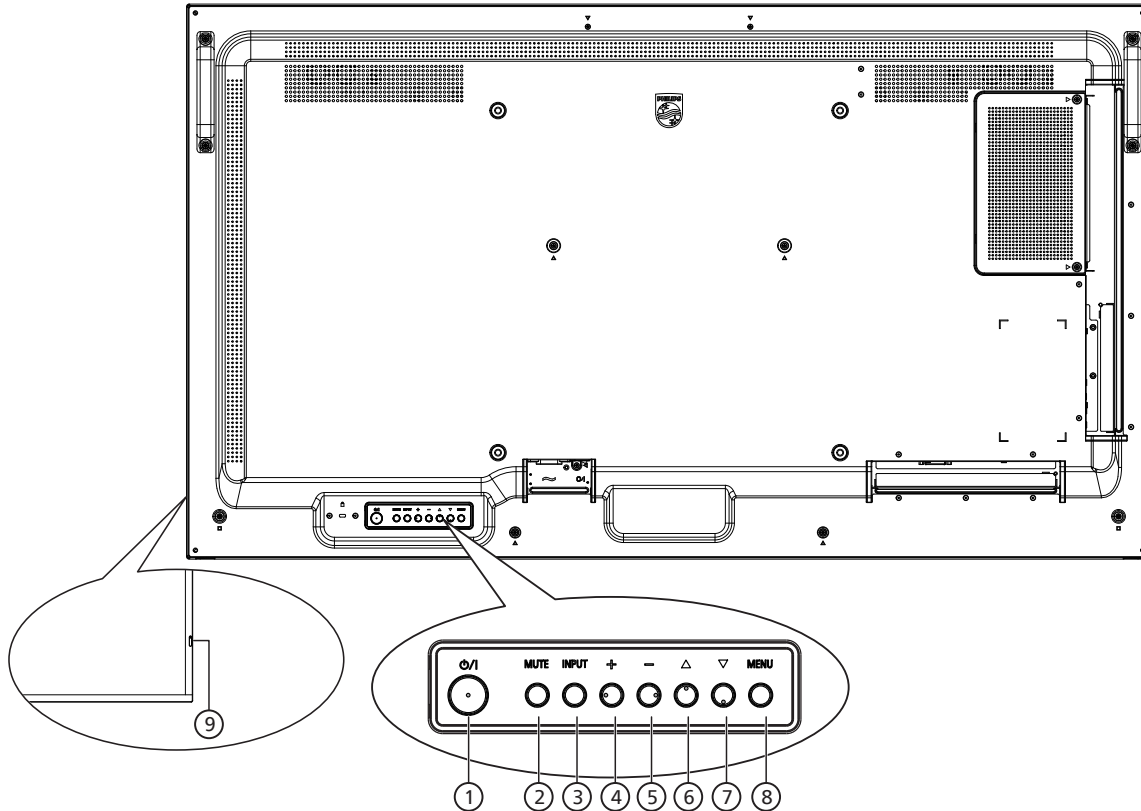

① [Power] button

Press this button to turn on the display or turn the display to standby mode.

② [MUTE] button

Press this button to mute the sound or reactivate sound.

③ [INPUT] button

Choose the input source.

Confirm a selection in the OSD menu.

④ [+] button

Increase the adjustment while OSD menu is on, or increase the audio output level while OSD menu is off.

⑤ [-] button

Decrease the adjustment while OSD menu is on, or decrease the audio output level while OSD menu is off.

⑥ [▲] button

Move the selected item one level up while the OSD menu is on.

⑦ [▼] button

Move the selected item one level down while the OSD menu is on.

⑧ [MENU] button

Return to the previous menu while the OSD menu is On. This button can also be used to activate the OSD menu when the OSD menu is Off.

⑨ Remote control sensor and power status indicator

- Receives command signals from the remote control.
- Indicates the operating status of the display:
 - Lights green when the display is turned on.
 - Lights red when the display is in standby mode.
 - Lights amber when the display enters Power Save mode or {WOL} is enabled.
 - When {SCHEDULE} is enabled, the light blinks amber and red.
 - If the light blinks red, it indicates that a failure has been detected.
 - Lights off when the main power of the display is turned off.

3.2. Input/Output Terminals

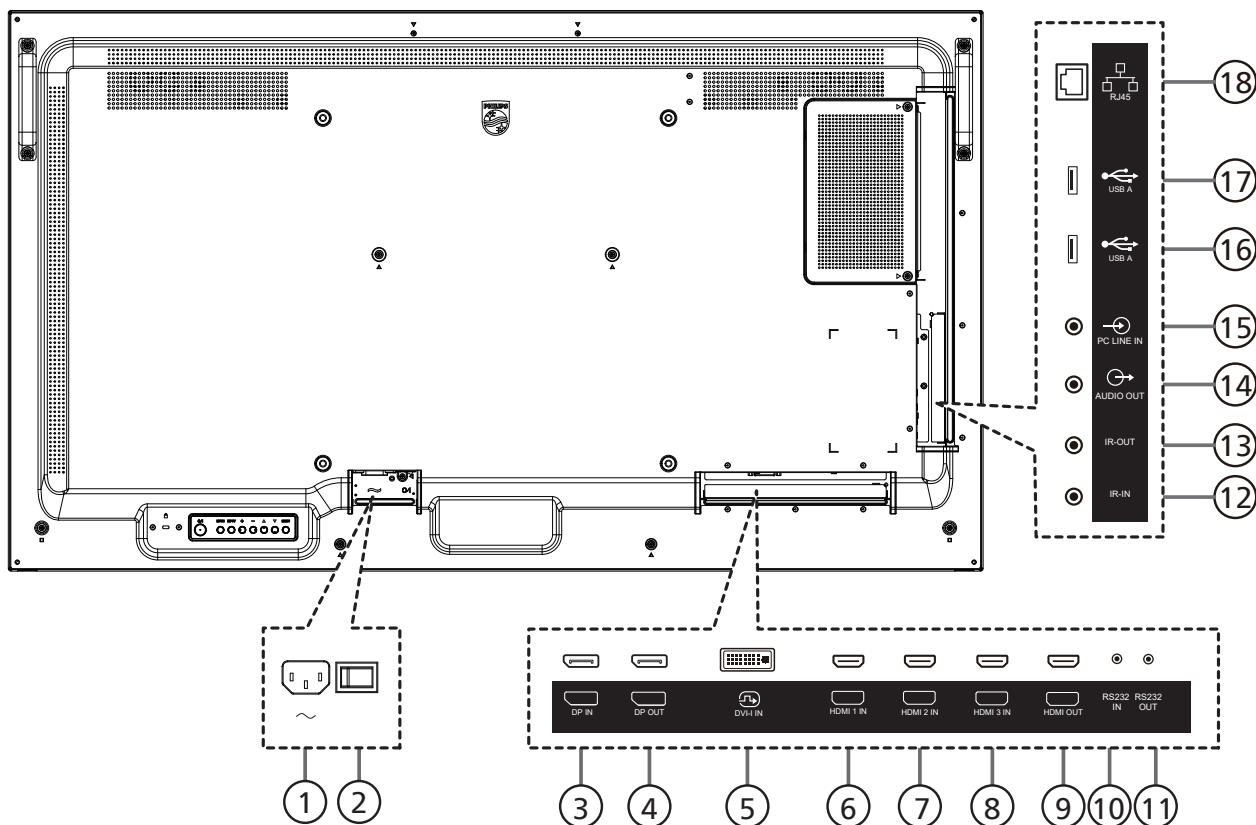

① **AC IN**

AC power input from the wall outlet.

② **MAIN POWER SWITCH**

Switch the main power between On and Off.

③ **DisplayPort IN** / ④ **DisplayPort OUT**

DisplayPort video input/output.

⑤ **DVI-I IN**

DVI-I video input.

⑥ **HDMI 1 IN** / ⑦ **HDMI 2 IN** / ⑧ **HDMI 3 IN** /

⑨ **HDMI OUT**

HDMI video/audio input / output

⑩ **RS232 IN** / ⑪ **RS232 OUT**

RS232 network input/output for the loop-through function.

⑫ **IR IN** / ⑬ **IR OUT**

IR signal input/output for the loop-through function.

NOTES:

- This display's remote control sensor will stop working if the jack [IR IN] is connected.
- To remotely control your A/V device via this display, refer to page 22 for **IR Pass Through connection**.

⑭ **AUDIO OUT**

Audio output to external AV device.

⑮ **PC LINE IN**

Audio input for VGA source (3.5mm stereo phone).

⑯ **USB A**

Connect your USB storage device and service port.

⑰ **USB A**

Connect your USB storage device and service port.

⑱ **RJ-45**

LAN control function for the use of remote control signal from control center.

3.3. Remote Control

3.3.1. General functions

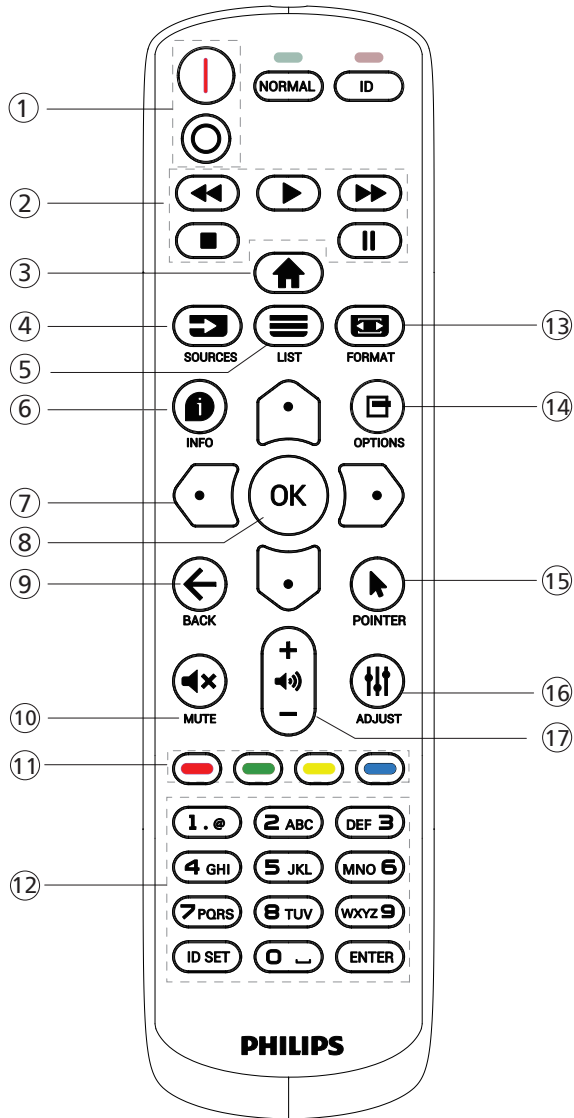

- ① **[I/O] POWER button**
[I] Turn on the power.
[O] Turn off the power.
- ② **[PLAY] buttons**
Control playback of media files.
- ③ **[HOME] HOME button**
Access the OSD menu.
- ④ **[SOURCES] SOURCE button**
Choose input source. Press [HOME] or [SOURCE] button to choose from **USB, Network, HDMI 1, HDMI 2, DisplayPort, DVI-D, YPbPr, AV or VGA**. Press [OK] button to confirm and exit.
- ⑤ **[LIST] LIST button**
Reserved.
- ⑥ **[INFO] INFO button**
Display information about current activity
- ⑦ **[NAVIGATION] NAVIGATION buttons**
Navigate through menus and choose items..
- ⑧ **[OK] button**
Confirm an entry or selection.
- ⑨ **[BACK] BACK button**
Return to the previous menu page or exit from the previous function.
- ⑩ **[MUTE] MUTE button**
Press to turn the mute function on/off.
- ⑪ **[COLOR] COLOR buttons**
Choose tasks or options
- ⑫ **[NUMERIC] buttons**
Enter text for network setting, and set up ID for ID mode
- ⑬ **[FORMAT] FORMAT button**
Change zoom mode.
- ⑭ **[OPTIONS] OPTIONS button**
Access currently available options, picture and sound menus.
- ⑮ **[POINTER] POINTER button**
No function on this model.
- ⑯ **[ADJUST] ADJUST button**
Access currently available options, picture and sound menus.
- ⑰ **[VOLUME] VOLUME button**
Adjust the volume.

3.3.2. ID Remote Control

Set remote control ID number when using several displays.

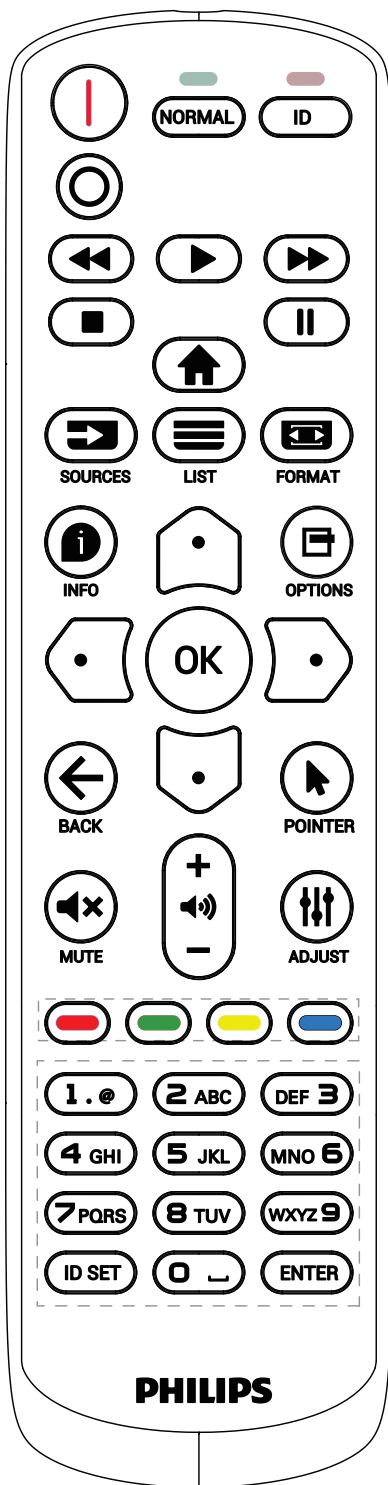

Press [ID] button. The red LED blinks twice.

1. Press [ID SET] button for more than 1 second to enter the ID Mode. The red LED lights up.
Press the [ID SET] button again to exit from ID mode. The red LED lights off.

Press the digit numbers [0] ~ [9] to select the display you want to control.

For example: press [0] and [1] for display No.1, press [1] and [1] for display No.11.

The numbers available are from [01] ~ [255].

2. Not pressing any button within 10 seconds will exit the ID Mode.
3. If a wrong button is pressed, wait 1 second after the red LED lights off and then lights up again, then press the correct digits again.
4. Press [ENTER] button to confirm. The red LED blinks twice and then lights off.

NOTE:

- Press [NORMAL] button. The green LED blinks twice, indicating the display is in normal operation.
- It is necessary to set up the ID number for each display before selecting its ID number.
- Use "||" (pause) key on the remote control to freeze the screen. Use "▶" (play) key on the remote control to unfreeze the screen.
- The "freeze" feature only can be adopted on "real" video sources like VGA, AV, YPbPr, HDMI, DVI, DP.
- Any operation on the remote control or video mode change will unfreeze the screen.

3.3.3. Inserting the Batteries in the Remote Control

The remote control is powered by two 1.5V AAA batteries.

To install or replace batteries:

1. Press and then slide the cover to open it.
2. Insert batteries with the correct polarity (+) and (-).
3. Replace the cover.

Caution:

Incorrect use of batteries may cause leakage or explosion. Be sure to follow the instructions below:

- Insert "AAA" batteries with the correct polarity (+ and -).
- Do not mix battery types.
- Do not use a new battery with a used one together. Otherwise, it may cause leakage or shorten the life of the batteries.
- Remove the dead batteries immediately to avoid battery leakage in the battery compartment. Do not touch exposed battery acid, as it may cause injury to your skin.
- Disposal of a battery into fire or a hot oven, or mechanically crushing or cutting of a battery, that can result in an explosion; leaving a battery in an extremely high temperature surrounding environment that can result in an explosion or the leakage of flammable liquid or gas; and a battery subjected to extremely low air pressure that may result in an explosion or the leakage of flammable liquid or gas.

NOTE: Remove the batteries from the battery compartment when not using for an extended period of time.

3.3.4. Handling the Remote Control

- Do not drop or apply shock to the remote control.
- Do not allow any liquid to get inside the remote control. If water has entered the remote control, wipe the remote control with a dry cloth immediately.
- Do not place the remote control near heat and steam sources.
- Do not attempt to disassemble the remote control, unless you need to place batteries in the remote control.

3.3.5. Operating range of the Remote Control

Pointing the remote control at the remote sensor on the display.

Use the remote control within 5 m from the sensor on the display at an angle of 20 degrees from the left and right.

NOTE:

- The remote control may not function properly when the remote control sensor on the display is under direct sunlight or strong illumination, or when an obstacle blocks the signal transmission.
- Use an IR sensor cable for better performance of the remote control. (Refer to 4.4. IR connection for details)

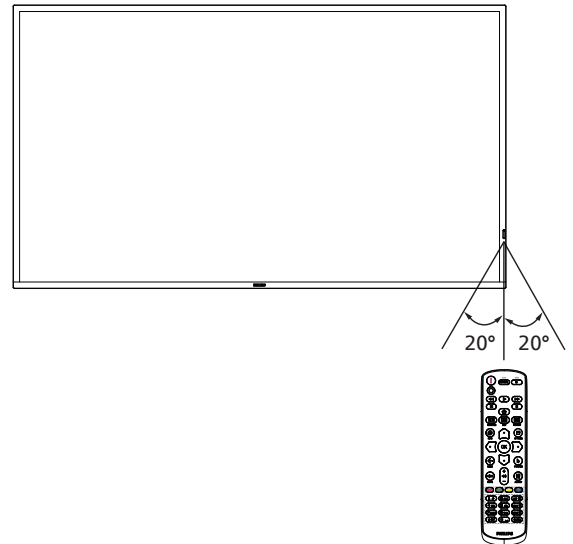

3.4. USB Cover

- Use the USB cover and screws to cover the USB stick and micro SD card.
 1. Install the USB stick and micro SD card.
 2. Use the screws provided to fix the USB cover.

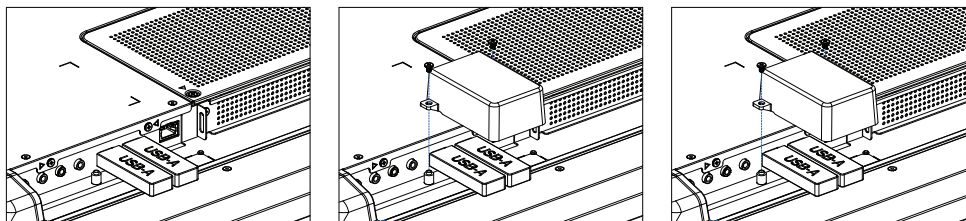

- Maximum USB stick size recommended:
43BDL6017P / 50BDL6017P / 55BDL6017P: 20(W)x10(H)x60(L) mm

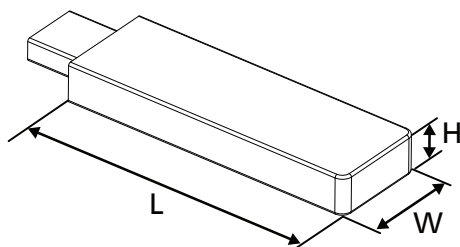

3.5. AC Switch Cover

- Use AC Switch Cover to cover the AC switch.
 1. Install the AC Switch Cover.
 2. Fix the AC Switch Cover with the screw provided.

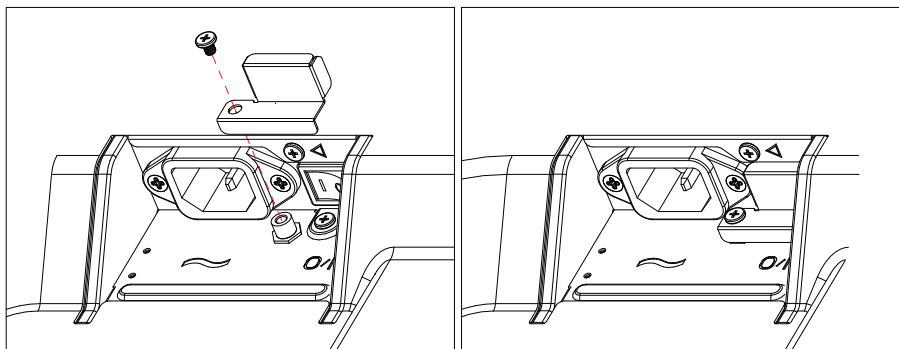

4. Connecting External Equipment

4.1. Connecting External Equipment

4.1.1. Using HDMI video input



4.2. Connecting a PC

4.2.1. Using DVI input

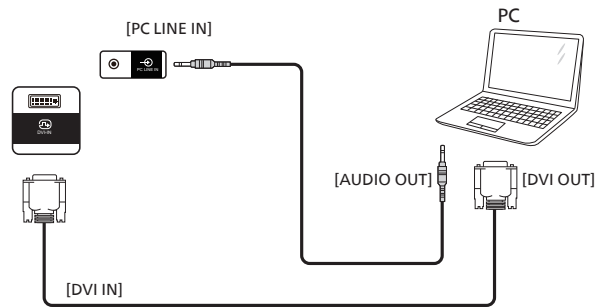

4.2.2. Using HDMI input

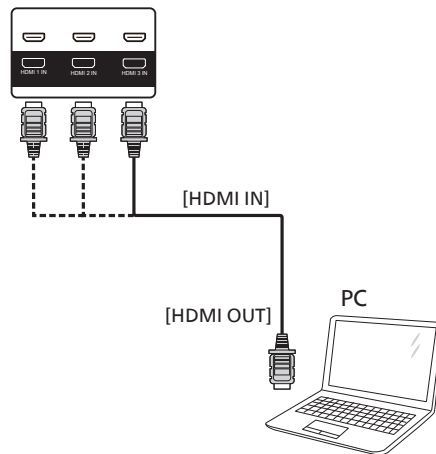

4.2.3. Using DP input

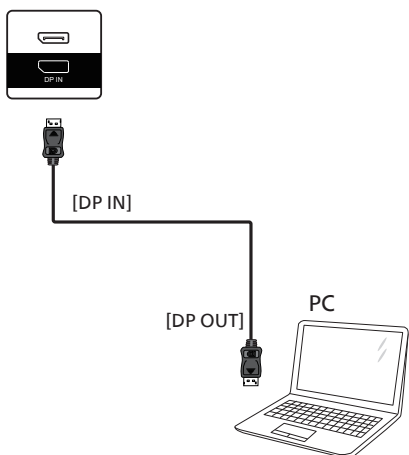

4.3. Connecting Multiple Displays in a Daisy-Chain Configuration

You can interconnect multiple displays to create a daisy-chain configuration for applications such as a menu board.

4.3.1. Display control connection

Connect the [RS232 OUT] connector of DISPLAY 1 to the [RS232 IN] connector of DISPLAY 2.

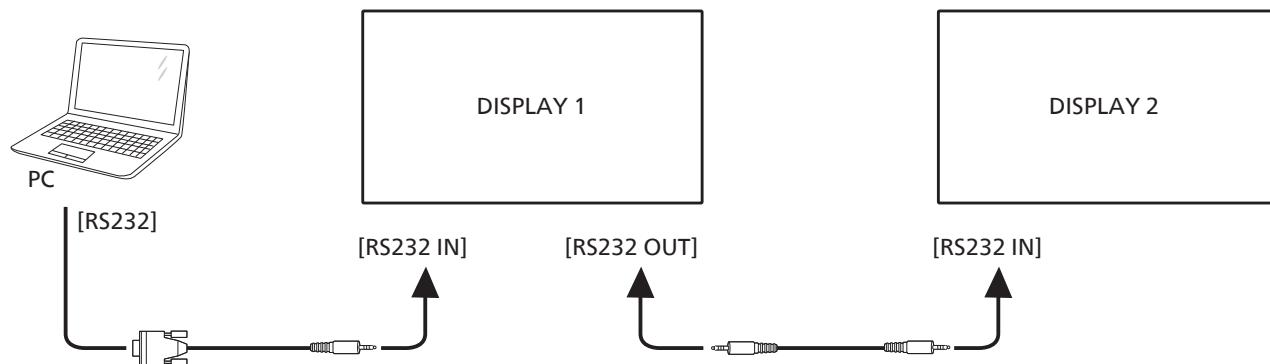

4.4. IR connection

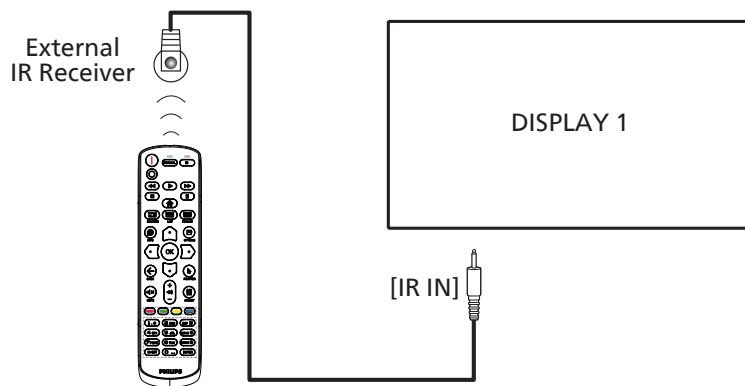

NOTE:

This display's remote control sensor will stop working if the [IR IN] is connected.

4.5. IR Pass-through Connection

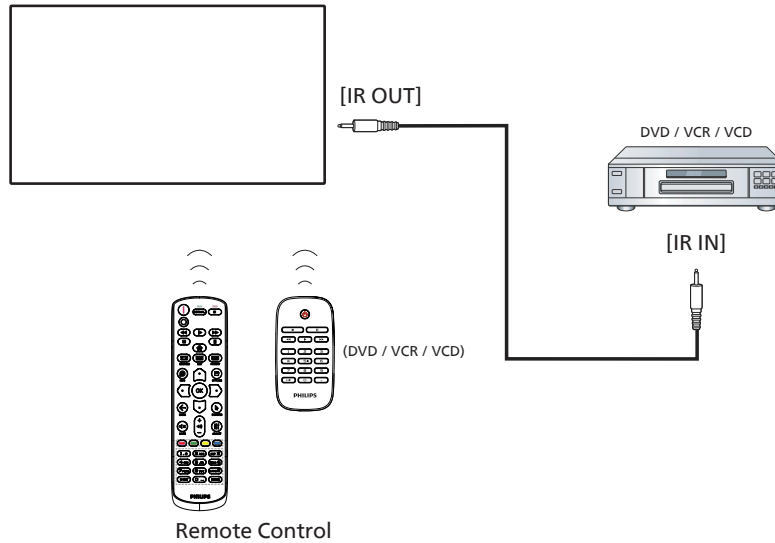

4.6. Wire-Connecting to Network

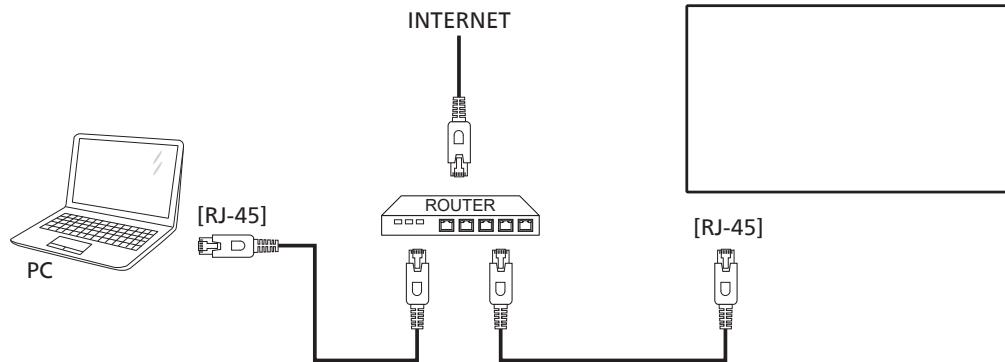

Network Settings:

1. Switch the router on and enable its DHCP setting.
2. Connect the router to this display with an Ethernet cable.
3. Press [**HOME**] HOME button on the remote control, then select **Setup**.
4. Select **Connect to network**, then press [**OK**] button.
5. Wait until this display finds the network connection.
6. If the "End User License Agreement" window prompts, accept the agreement.

NOTE: Use a shielded CAT-5 Ethernet cable for connection to comply with the EMC directive.

5. Operation

NOTE: The control button described in this section is mainly on the remote control unless specified otherwise.

5.1. Play multimedia files from USB device

1. Connect your USB device to the USB port on the display.

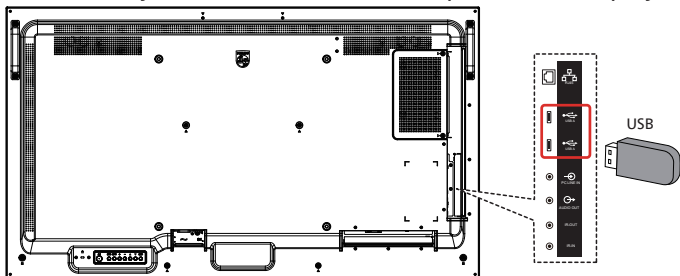

2. Press [SOURCE] button, choose **Media Player**, and press [OK] button.

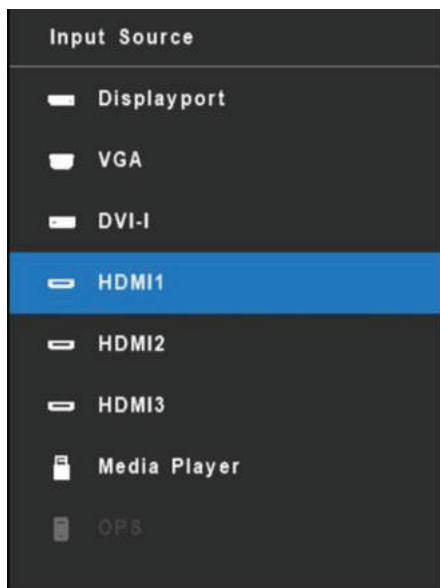

3. The playable files for the connected USB device will be detected automatically. The files are automatically sorted into 3 types: **Photo**, **Music** and **Movie**.

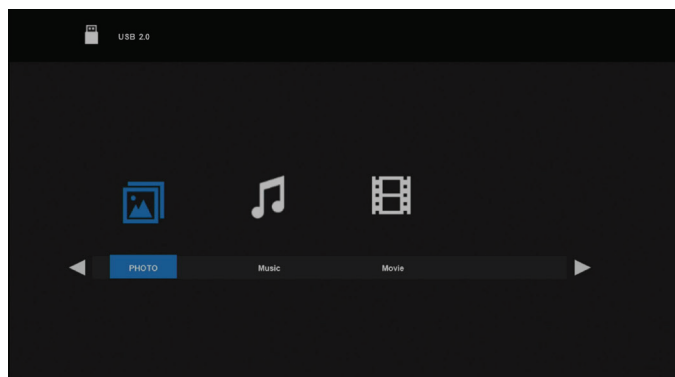

4. Press [LEFT] or [RIGHT] button to choose the item. Press [OK] button to enter its play list.

5. Press [UP], [DOWN], [LEFT] or [RIGHT] button to choose a file. Press [OK] or [RIGHT] button to start playing.
6. Follow the on-screen instruction to control the play option.
7. Press [PLAY] buttons (▶ || ◀ ◀ ▶▶) to control playing.

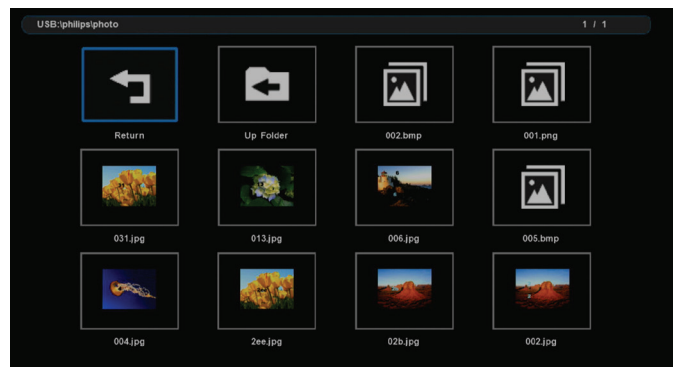

8. Press [UP], [DOWN], [LEFT] or [RIGHT] button to choose "Return" item then press [OK] button to return to the top layer.

6. OSD Menu

An overview of the On-Screen Display (OSD) structure is shown below. You can use it as a reference for further adjustment of your display.

6.1. Navigating the OSD Menu

6.1.1. Navigating the OSD menu using the remote control

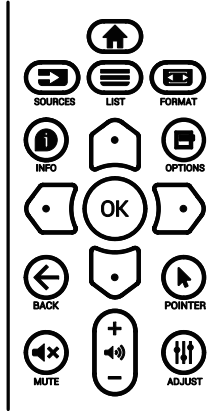

1. Press [**HOME**] button on the remote control to display the OSD menu.
2. Press [**HOME**] or [**OPTION**] button to select the item to adjust.
3. Press [**OK**] or [**DOWN**] button to enter the submenu.
4. In the submenu, press [**HOME**] or [**OPTION**] button to toggle between items, or press [**LEFT**] or [**RIGHT**] button to adjust the settings. If there is a submenu, press [**OK**] or [**DOWN**] button to enter the submenu.
5. Press [**LEFT**] button to return to the previous menu, or press [**HOME**] button to exit from the OSD menu.

6.1.2. Navigating the OSD menu using the display's control buttons

1. Press [**MENU**] button to display the OSD menu.
2. Press [**+**] or [**-**] button to select the item to adjust.
3. Press [**+**] button to enter the submenu.
4. In the submenu, press [**▲**] or [**▼**] button to toggle between items, or press [**+**] or [**-**] button to adjust settings. If there is a submenu, press [**+**] button to enter the submenu.
5. Press [**MENU**] button to return to the previous menu, or keep pressing [**MENU**] button to exit from the OSD menu.

6.2. OSD Menu Overview

6.2.1. Picture menu

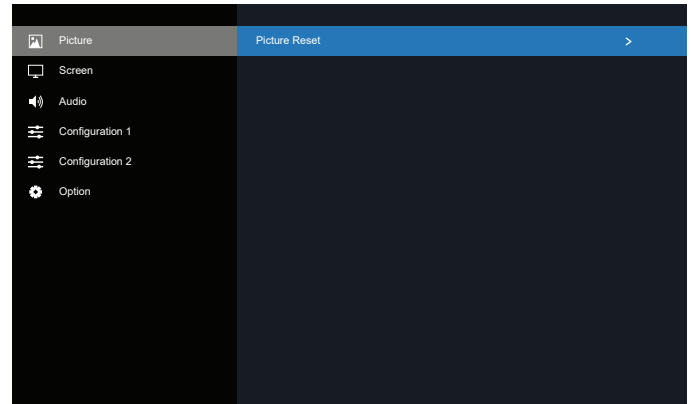
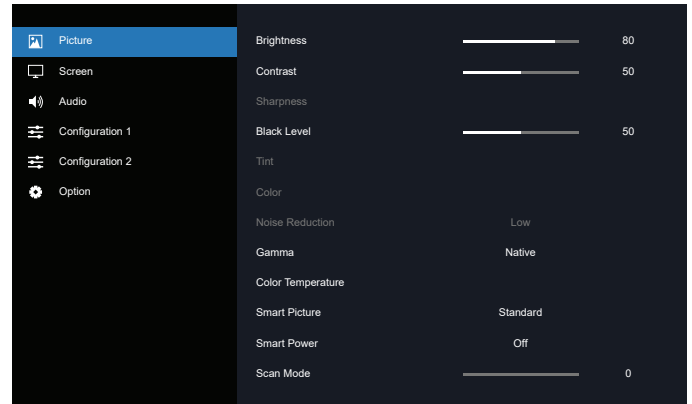

Brightness

Adjust the brightness of this display's backlight.

Contrast

Adjust the contrast ratio for the input signal.

Sharpness

This function is digitally capable to keep a distinct image at all times.

Adjust the sharpness of the picture for each picture mode.

Black Level

Adjust the image brightness for the background.

NOTE: sRGB picture mode is standard and cannot be changed.

Tint (Hue)

Adjust the tint of the screen.

Press [**+**] button the flesh tone color becomes greenish.

Press [**-**] button the flesh tone color becomes purplish.

NOTE: VIDEO mode only.

Color (Saturation)

Adjust the color of the screen.

Press [**+**] button to increase color depth.

Press [**-**] button to decrease color depth.

NOTE: VIDEO mode only.

Noise Reduction

Adjust the noise reduction level.

Gamma

Select a display gamma. It refers to the brightness performance curve of signal input. Choose from {Native} / {2.2} / {2.4} / {s gamma} / {D-image}.

NOTE: sRGB picture mode is standard and cannot be changed.

Color Temperature

It is used to adjust the color temperature.

The image becomes reddish as the color temperature decreases, and becomes bluish as the color temperature increases.

Smart Picture

PQ setting

{Standard}/{Highbright}/{Warm}.

Smart Power

Smart Power control is not relative to brightness control.

1. Initial Brightness Setting
The power consumption is set to 70% of the maximum power consumption.
2. Smart Power
OFF: No adaptation.
MEDIUM: Power consumption is 65% of maximum, relative to current settings.
HIGH: Power consumption is 80% of maximum, relative to current settings.

Scan Mode

Change the display area of the image.

Picture Reset

Reset all settings in the Picture menu.

Select "Yes" and press "SET" button to restore to factory preset data.

Press "EXIT" button to cancel and then return to the previous menu.

6.2.2. Screen menu

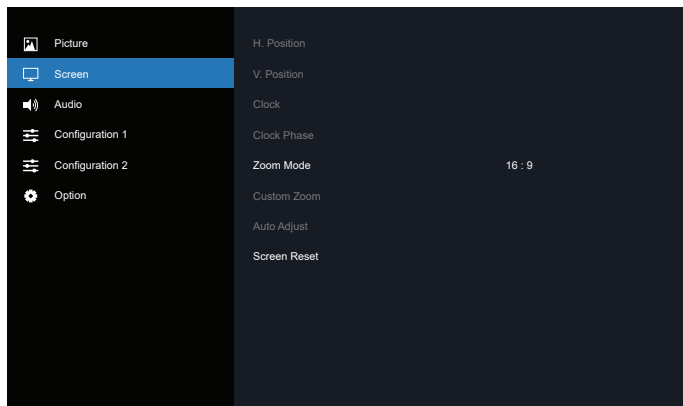

H position

Control Horizontal Image position within the display area of the LCD.

Press [+] button to move screen to right.

Press [-] button to move screen to left.

NOTE: VGA input only.

V position

Control Vertical Image position within the display area of the LCD.

Press [+] button to move the screen upward.

Press [-] button to move the screen downward.

NOTE: VGA input only.

Clock

Press [+] button to expand the width of the image on the screen to the right.

Press [-] button to narrow the width of the image on the screen to the left.

NOTE: VGA input only.

Clock Phase

Improves focus, clarity and image stability by increasing or decreasing this setting.

NOTE: VGA input only.

Zoom Mode

PC mode: {Full} / {4:3} / {1:1} / {16:9} / {Custom}.

Video mode: {Full} / {4:3} / {1:1} / {16:9} / {Custom}.

* is defined by input. If the input is windows, the setting will apply to all same input.

T how the latest setting.



	Full This mode restores the correct proportions of pictures transmitted in 16:9 using the full screen display.
	4:3 The picture is reproduced in 4:3 format and a black band is displayed on either side of the picture.
	1:1 This mode displays the image pixel-by-pixel on screen without scaling the original image size.
	16:9 The picture is reproduced in 16:9 format and a black band at the top and bottom.
	Custom Choose to apply the custom zoom settings in the Custom Zoom submenu.

Custom Zoom

You can use this function to further customize the zoom settings to suit the image you want to display.

NOTE: This item is functional only when the {Zoom mode} is set to {Custom}.

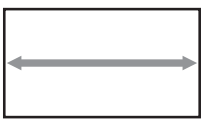
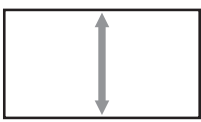
	Zoom Expands the horizontal and vertical sizes of the image simultaneously.
--	---

	H zoom Expands the horizontal size of the image only.
	V zoom Expands the vertical size of the image only.
	H position Moves the horizontal position of the image left or right.
	V position Moves the vertical position of the image up or down.

Auto Adjust

Press "Set" to detect and adjust H position, V position, Clock, Phase automatically.

NOTE: VGA input only.

Screen Reset

Reset all settings in the Screen menu to factory preset values.

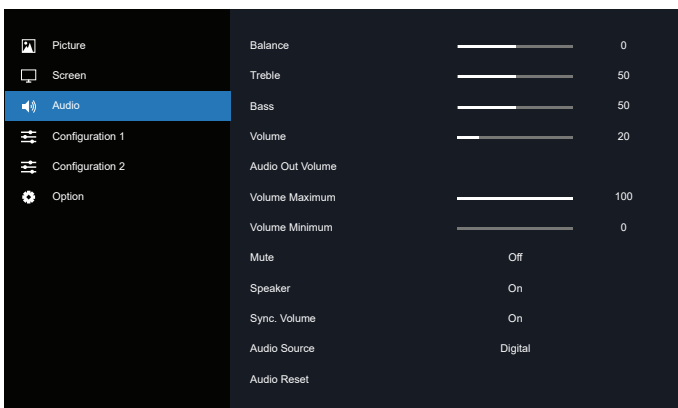
6.2.3. Audio**Balance**

Adjust to emphasize left or right audio output balance.

Treble

Adjust to increase or decrease higher-pitched sounds.

Bass

Adjust to increase or decrease lower-pitched sounds.

Volume

Adjust the volume.

Audio Out Volume

Adjust to increase or decrease the line out audio output level.

Minimum volume ≤ Volume ≤ Maximum volume

NOTE: This function will be disabled when Audio Out Sync is ON.

Volume Maximum

Adjust your own limitation for the maximum volume setting.

Volume Minimum

Adjust your own limitation for the minimum volume setting.

Mute

Turn on/off the mute function.

Speaker

Turn on/off the internal speaker.

NOTE: This function is only available when "Audio Out Sync" is on.

Sync. Volume

Enable/disable audio out (line out) volume adjustability to sync with internal speakers volume, but PD Internal speaker sound will be forced to be mute.

Audio source

Select the audio input source.

Analog: audio from audio input.

Digital : audio from HDMI/DVI audio.

Displayport: audio from DP

Audio Reset

Reset all settings in the Audio menu to factory preset values.

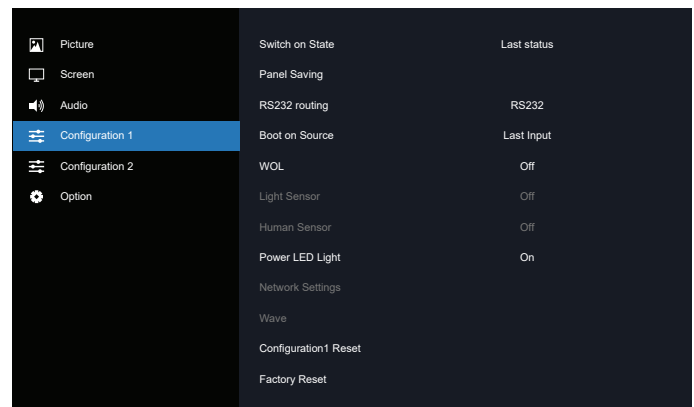
6.2.4. Configuration1 menu**Switch on State**

Select the display status when you connect the power cord next time.

- {Power off} - The display will remain off when the power cord is connected to a wall outlet.
- {Forced on} - The display will turn on when the power cord is connected to a wall outlet.
- {Last status} - The display will return to the previous power status (on/off/standby) when removing and replacing the power cord.

Panel Saving

Choose to enable the panel saving functions and thus reduce the risk of "image persistence" or "ghost-imaging".

- {Brightness} - Select {On} and the image brightness will be reduced to an appropriate level. The Brightness setting in the Picture menu will be unavailable when selected.
- {Pixel shift} - Select the time interval ({Auto} / {10 ~ 900} Seconds / {Off}) for the display to slightly expand the image size and shift the position of pixels in four directions (up, down, left, or right).

RS232 routing

Select the network control port.

Choose from: {RS232} / {LAN ->RS232}.

Boot On Source

Select the source when booting up.

- Input: select input source when boot up.
 - Play List: select playlist index for Media player source.
- None: no playlist autoplay function depends on {OPTION}
-> { Autoplay}.
- 1~7: playlist number.
Autoplay: autoplay function .

WOL

Choose to turn on or off the wake on LAN function.

Choose from : {Off} / { On}

Light Sensor (require Philips accessory CRD41 External Sensor Box)

Choose to turn on or off backlight adjustment according to environment brightness.

Choose from : {Off} / { On}

Human Sensor (require Philips accessory CRD41 External Sensor Box)

This function will turn on the backlight when it senses the presence of human and turn it off after a specified period of time.

The options are:

- {Off} (Default), {10 Min.}, {20 Min.}, {30 Min.}, {40 Min.}, {50 Min.}, {60 Min.}

Power LED Light

Select {Off} to turn off the indicator.

Network Settings

- DHCP Enable -> Cannot modify IP address/Subnet mask/ Default gateway
- DHCP Disable-> Can manually input IP address/Subnet mask/Default gateway.

Wave

- {Claim Status} - Get from Wave. (Claimed / Unclaimed)
- {Claim Code} - Show 6 digital number from Wave.
- {Serial No} - Show scaler Serial number.
- {CTN} - Show scaler model name.
- {Enter Claim Code} - It's an input digital entry.
- {SET} - Set claim code to Wave.
- {Error Code} - Show error code, get from Wave.

Configuration1 Reset

Reset all settings in Configuration1 menu to the factory preset values.

Factory Reset

Reset all settings in the OSD menus of {Picture}, {Screen}, {Audio}, {PIP}, {Configuration1}, {Configuration2}, and {Advanced option} to the factory preset values.

Press [↶] or [↷] button to select {Reset}, and press [OK] button to do the reset.

6.2.5. Configuration2 menu

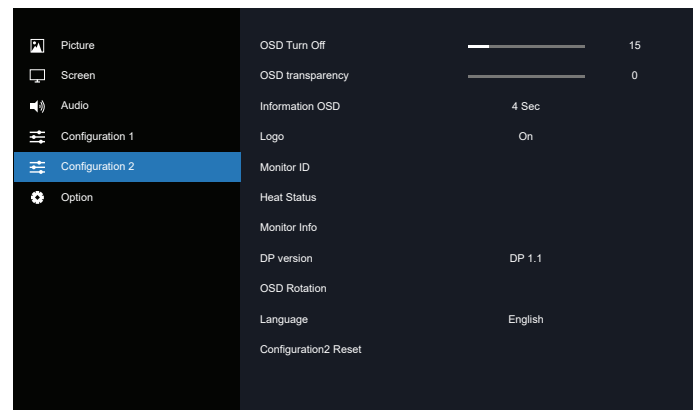

OSD Turn Off

Set the period of time the OSD (on-screen display) menu stays on the screen.

The options are: {5 ~ 100} seconds.

OSD Transparency

Adjust OSD transparency.

- {0} - Transparency off.
- {1-100} - Transparency level 1-100

Information OSD

Set the period of time the information OSD is displayed on the upper right corner of the screen. The information OSD will display when input signal is changed.

The information OSD will remain on the screen with {Off} selection.

The options are: {1 - 60} seconds.

Logo

Choose to enable or disable the picture of Logo when turning on your display.

The options are: {Off} / {On}

Monitor ID

Set the ID number for controlling the display via the RS232 connection.

Each display must have a unique ID number when multiple sets of display are connected. Monitor ID number range is between 1 to 255.

- {1-255} – {Monitor ID} The default setting is 1.
- {1-254} – {Monitor group} The default setting is 1.
- {1-15} – {Tiling matrix} The default setting is 1.
- {Auto ID} The {Auto ID} setup function enables setting up {Monitor ID} of connected machine according to {Tiling matrix} settings. Example: Tiling matrix sets as 4
- {Tiling matrix}: Tiling matrix number range is between 1 to 15. The default setting is 1.

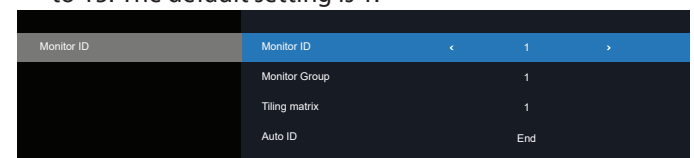

- {Auto ID}: The option are: {Start} / {End}. The default is {End}.

- Switch to Start option to set up IDs of machines backward from current one.
Once the setup is completed, the option exits to End automatically.
To use this function, serially connect all machines with RS-232 cable and set their Control ports to RS-232 too.

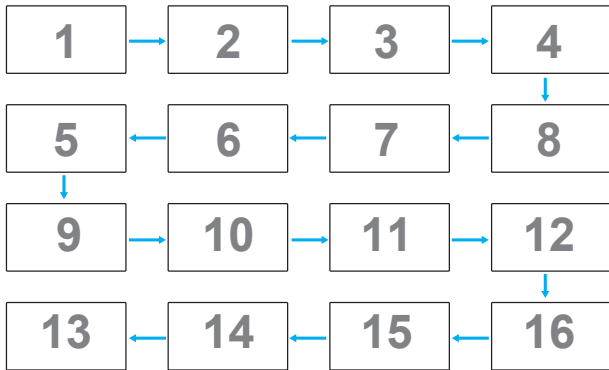

Heat Status

This function allows you to check the thermal status at any time.

Monitor Information

Shows information about your display, including Input source, Resolution, Model name, SW version, serial number, operation hours and MAC address.

Information	
Input Source	Displayport
Resolution	
Model Name	XXXXXX
SW Version	XXXXX
Serial No	
Operation Hours	0HR
MAC Address	XXXXXX

DP version

DisplayPort support mode.

The options are:

- {DP 1.1} (Default) : DP 1.1 single stream(clone mode)
- {DP 1.2}: DP 1.2

NOTE:

- The DP version must be set the same for all daisy chain displays.
- For 3840x2160, the dot clock timing should be 533MHz.
- DP 1.1 not support 4K/60Hz timing.

NOTE: DP input only.

HDMI EDID

Switch HDMI EDID type: {HDMI 1.4}, {HDMI 2.0}.

NOTE: HDMI input only.

OSD Rotation

Landscape/Portrait

Language

Set OSD menu language.

Configuration2 reset

Reset all settings in Configuration2 menu to the factory preset values.

6.2.6. Option

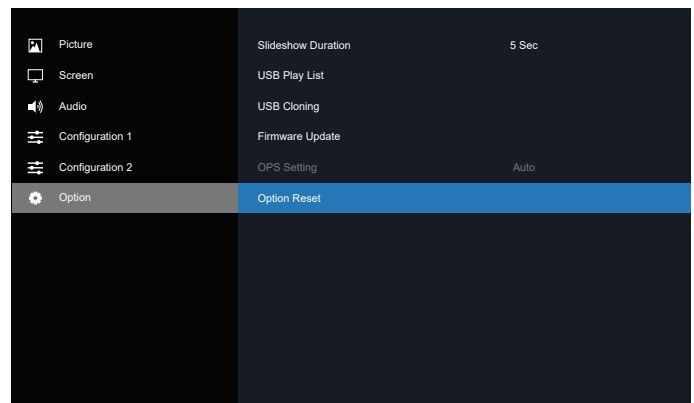
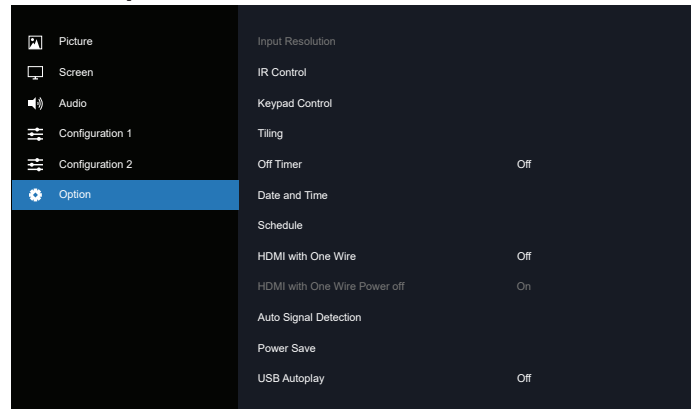

Input Resolution

Set the resolution of the VGA input. This is only required when the display is unable to detect the VGA input resolution correctly.

NOTE: This item is functional for VGA input only.

The options are:

- {1024x768 / 1280x768 / 1360x768 / 1366x768}
- {1400x1050 / 1680x1050}
- {1600x1200 / 1920x1200}
- {Auto}: Determines the resolution automatically.

The selected settings will become effective after turning off the power and turning it on again.

IR Control

Select the operation mode of the remote control when multiple displays are connected via an RS232C connection.

- {Normal} - All displays can be operated normally by the remote control unit.
- {Primary} - Designate this display as the primary display for remote control operation. Only this display can be operated by the remote control. (In primary mode, IR key will always be processed regardless the monitor id/group settings).
- {Secondary} - Designate this display as the secondary display. This display can not be operated by the remote control, and will only receive the control signal from the primary display via the RS232C connection.

- {Lock All} / {Lock all but Volume} / {Lock all but Power} / {Lock all except PWR & VOL} - Lock the remote control function of this display. To unlock, press and hold the [INFO] button on the remote control for 6 (six) seconds.

Keyboard Control

Choose to enable or disable the display keyboard (control buttons) function.

- {Unlock} - Enable the keyboard function.
- {Lock All} / {Lock all but Volume} / {Lock all but Power} / {Lock all except PWR & VOL} - Disable the keyboard function.

NOTE: "Keyboard Control Lock Mode" This function completely disables the access to all Keyboard Control functions. To enable or disable the keyboard control lock, press both [+] and [↓] buttons and hold down continuously for more than 3 seconds.

Tiling

With this function, you can create a single large-screen matrix (video wall) that consists of up to 225 sets of this display (up to 15-sets on the vertical and 15-sets on the horizontal sides). This function requires a daisy-chain connection.

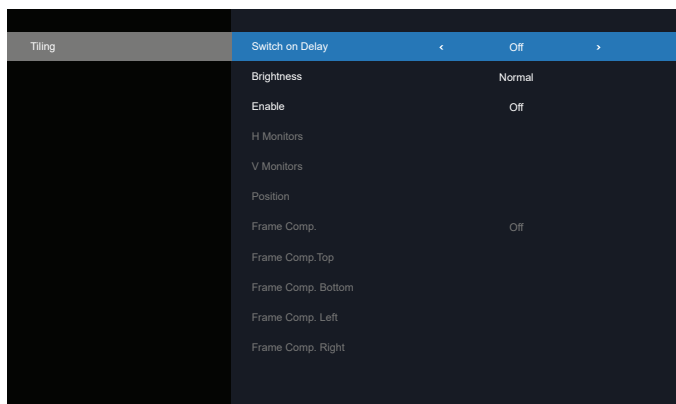

- **Switch on delay**
Set the power-on delaying time (in seconds). The default option {Auto} allows a sequential powering-on for each display by their ID number when multiple displays are connected.
The options are: {Off(0) / Auto(1) / 2-255}
- **Brightness: {Normal} / {ACS}**
{Normal}: Adjust the overall image and background screen brightness (backlight).
{ACS}: Automatic Calibration System. The default value before adjustment is the same as OSD brightness value, e.g., 70.
- **Enable**
Enable or disable the Tiling function. If {On} is selected, the display will apply the settings in {H monitors}, {V monitors}, {Position}, and {Frame comp.}.
- **H monitors**
Set the number of displays in horizontal side.
- **V monitors**
Set the number of displays in vertical side.
- **Position**
Set the position of this display in the screen matrix.

Example: 2 x 2 screen matrix (4 displays)

H monitors = 2 displays

V monitors = 2 displays

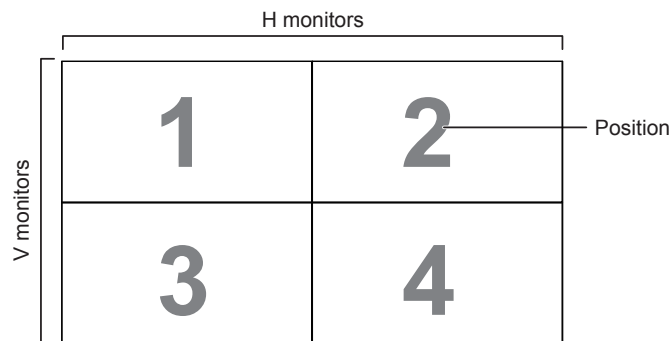

Example: 5 x 5 screen matrix (25 displays)

H monitors = 5 displays

V monitors = 5 displays

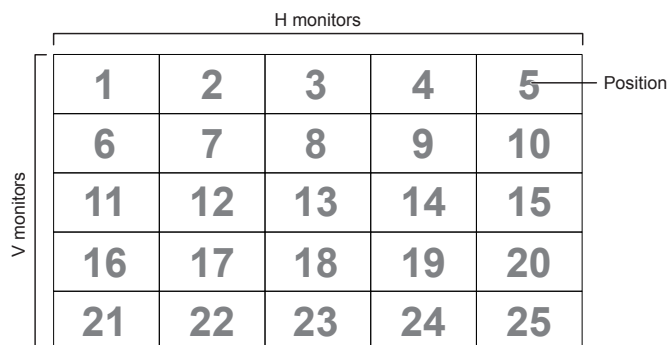

- **Frame comp.**
Turn the frame compensation function On or Off. If you select {On}, the display will adjust the image to compensate for the width of the display bezels in order to accurately display the image.
- **Frame comp. Top**
Adjust the top frame compensation.
- **Frame comp. Bottom**
Adjust the bottom frame compensation.
- **Frame comp. Left**
Adjust the left frame compensation.
- **Frame comp. Right**
Adjust the right frame compensation.

Off Timer

Set the automatic power-off time

Date and Time

Set the current date and time for the display's internal clock.

NOTES:

The definition and behavior of the Daylight saving time:

The current implementation of daylight saving is a reminder tool for the user who doesn't know how to adjust the clock of daylight saving.

It does not adjust the real time clock automatically. The problem is that there are no standard rules on when to adjust the clock defined by region or country. To solve this problem, the user must be able to set the daylight saving start/end date. When daylight saving correction is on (user selectable) then the real time clock should be adjusted at the time set of the daylight saving on/off date. At the start date of daylight saving, the clock should be adjusted 1 hour

forward at 2 o'clock. At the end date of daylight saving, the clock should be adjusted 1 hour backward at 2 o'clock.

The existing daylight on/off menu should be replaced by the following menu structure:

The menu item {Daylight saving} opens the submenu that contains the following items:

- Menu item {Daylight saving start date} Selection item {1st, 2nd, 3rd, 4th, last} Sunday of selection item {1-12 month}
- Menu item {Daylight saving stop date} Selection item {1st, 2nd, 3rd, 4th, last} Sunday of selection item {1-12 month}
- Menu item {Correction time} Selection item {0.5, 1.0, 1.5, 2.0} hour
- Menu item {Daylight saving} Selection item {on, off}

When "daylight saving" is "on", the real time clock will be adjusted automatically at the daylight saving time (e.g. April 5, 2015, 02.00 o'clock: time will be set 1 hour later or October 25, 2015, 02.00 o'clock: time will be set 1 hour earlier).

Schedule

This function allows you to program up to 7 (seven) different scheduled time intervals for the display to activate.

You can select:

- The time for the display to turn On and Off.
- The days in a week for the display to activate.
- The input source the display will use for each scheduled activation period.

NOTE: It is recommended that you set up the current date and time in the {Date and time} menu before using this function.

1. Press [OK] or [D] button to enter the submenu.

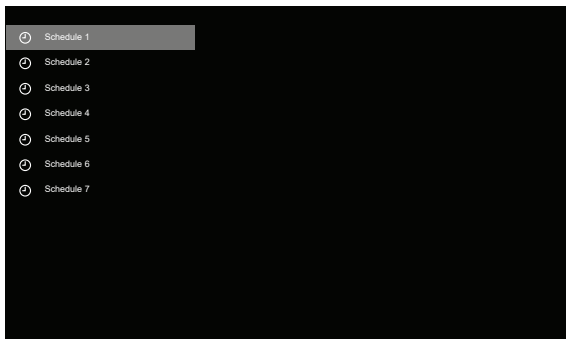

2. Press [H] or [M] button to select a schedule item (item number 1 - 7), and press [OK] or [D] button to enter the submenu.

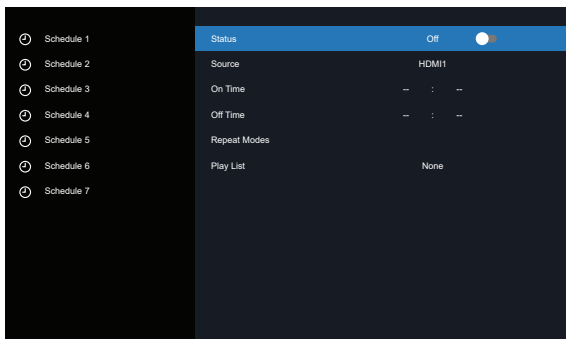

- {Status} - Press [C] or [D] button to select the status On or Off.

- {Source} - Press [C] or [D] button to select the input source.
- {On Time} - Press [H] or [M] button to adjust and the display will turn on at the specified time.
- {Off Time} - Press [H] or [M] button to adjust and the display will turn off at the specified time. Leave hour and minute options empty if you do not want to use the function of power-on or power-off schedule.
- {Repeat modes} - Press [D] button to select which day in a week this schedule item will take effect, and then press the [OK] button.

NOTE:

The scheduler cannot work cross midnight in one schedule with no repeats or only one schedule day is selected.

3. For additional schedule settings, press [←], then repeat the steps above. A check mark in the box next to the number of the schedule item indicates that the selected schedule is in effect.

NOTES:

- If the schedules overlap, the scheduled power-on time takes priority over scheduled power-off time.
- If there are two schedule items programmed for the same time, the highest numbered schedule takes priority. For example, if schedule items #1 and #2 both set the display to power on at 7:00 AM and off at 5:00 PM, then only schedule item # 2 will take effect.

HDMI with One Wire

CEC control.

- {Off} - Disable CEC.(Default)
- {On} - Enable CEC.

HDMI with One Wire Power off

Only available if "HDMI with One Wire" is on.

- {Off} - System Standby disable.(Default)
- {On} - System Standby enables.

Auto signal detection

This function allows the display to detect and display available signal sources automatically.

- {Off} - Once an input is connected, it can only be selected manually.

If the selected input has signal, set the system to display the image automatically according to the search order of each option.

The options are: {Auto} / {Failover}

- {Auto}: Displayport->VGA->DVI-I->HDMI1->HDMI2->HDMI3->Media Player
- {Failover}
 - Failover 1: User-defined setting. Default:HDMI 1.
 - Failover 2: User-defined setting. Default:HDMI 1.
 - Failover 3: User-defined setting. Default:HDMI 1.
 - Failover 4: User-defined setting. Default:HDMI 1.
 - Failover 5: User-defined setting. Default:HDMI 1.
 - Failover 6: User-defined setting. Default:HDMI 1.
 - Failover 7: User-defined setting. Default:HDMI 1.

If the primary signal is lost, the display will begin failover by searching for the next available source defined in the priority list.

Please note that failover will suspend under the following conditions and failover will resume when signal is lost again.

- **Boot On Source** : When the display is powered on, it will go to the source defined in this OSD option.
- **Scheduler**: When the display is powered on by scheduler, it will go to the corresponding source according to the current time.
- **User operation**: No matter what current source it is, when user manually changes source, the failover will suspend.

To make sure failover starts from the 1st priority source after powering on, please set the 1st priority source as boot on source too.

Power Save

Mode 1 [TCP off, WOL on, auto off]

Mode 2 [TCP off, WOL on, auto on/off]

Mode 3 [TCP on, WOL off, auto on/off]

Mode 4 [TCP on, WOL off, no auto on/off]

Autoplay

Choose to play source type. The options are: {Off} / {SD} / {USB}.

NOTE:

To use USB Autoplay

1. Create a folder which should be named as "autoplay" in the USB disk.
2. Put the sources(PHOTO/Movie) which should be named as alphabet and digital in the autoplay folder.
3. After boot on or inserting USB on the system, USB Autoplay function starts automatically.

Slideshow Duration

Duration of each picture for autoplay and Play List.

Play List

Choose 1 playlist to play, supporting up to 7 playlists.

NOTE:

To use USB Playlist

1. Create a folder which should be named as "playlistN" in the USB disk.

(N means playlist number1~7, ex: USB Play List 1: "playlist1" folder in USB)

2. Put the sources(PHOTO/Movie) which should be named as alphabet and digital in the "playlistN" folder

USB Cloning

Copy PD settings from one set to another.

Import: Import settings from another set.

Export: Export settings to another set.

Firmware update

Update firmware via SD or USB disk.

Option Reset

Reset all settings in the Option menu to factory preset values.

7. Supported Media Formats

USB Multimedia Formats

Video format		
Video Codec	Resolution	Bit Rate
MPEG1/2	1080P@30fps	40Mbps
H.264	4096x2160@60fps	135Mbps
HEVC/H.265	4096x2176@60fps	100Mbps
WMV3	1080P@30fps	40Mbps
Motion JPEG	640x480@30fps	40Mbps

Audio format			
Audio Codec	Sampling Rate	Channel	Bit Rate
MPEG1/2 Layer1	16KHz-48KHz	Up to 2	32Kbps-448Kbps
MPEG1/2 Layer2	16KHz-48KHz	Up to 2	8Kbps-384Kbps
MPEG1/2 Layer3	16KHz-48KHz	Up to 2	8Kbps-320Kbps
AAC, HEAAC	8KHz-48KHz	Up to 5.1	32Kbps-448Kbps

Photo format	
Image	Max. Resolution
JPEG	3840x2160
PNG	3840x2160
BMP	3840x2160

NOTES:

- Sound or video may not work if the contents have a standard bit rate/frame rate above the compatible Frame/sec listed in the table above.
- Video content with a Bit rate or Frame rate larger than the rate specified in the table above can cause choppy video during playback.

HDCP support table

Input Source	HDMI Ver	HDCP 1.4	HDCP 2.2
DVI	HDMI 1.4b	V	X
HDMI1	HDMI 1.4b	V	X
	HDMI 2.0	V	V
HDMI2	HDMI 1.4b	V	X
	HDMI 2.0	V	V
HDMI3	HDMI 1.4b	V	X
	HDMI 2.0	V	V

8. Input Mode

Timing support:

Item	Resolution	H.Freq. (KHz)	V.Freq. (Hz)
1	720x400 @70Hz DOS	31.469	70.087
2	640x480 @60Hz DMT	31.469	59.94
3	640x480 @67Hz MAC	35	66.667
4	640x480 @72Hz DMT	37.861	72.809
5	640x480 @75Hz DMT	37.5	75
6	800x600 @56Hz DMT	35.156	56.25
7	800x600 @60Hz DMT	37.879	60.317
8	800x600 @72Hz DMT	48.077	72.188
9	800x600 @75Hz DMT	46.875	75
10	1024x768 @60Hz DMT	48.363	60.004
11	1024x768 @70Hz DMT	56.476	70.069
12	1024x768 @75Hz DMT	60.023	75.029
13	1152x864 @75Hz DMT	67.5	75
14	1152x870 @75Hz MAC	68.681	75.062
15	1280x720 @60Hz CVT16:9	44.772	59.855
16	1280x800 @60Hz CVT16:10	49.702	59.81
17	1280x1024 @60Hz DMT	63.981	60.02
18	1440x900 @60Hz CVT16:10 R	55.469	59.901
19	1440x900 @60Hz CVT16:10	55.935	59.887
20	1600x1200 @60Hz CVT16:9	75	60
21	1680x1050 @60Hz CVT16:9 R	64.674	59.883
22	1680x1050 @60Hz CVT16:9	65.29	59.954
23	1920x1080 @60Hz CVT-RB / XBOX360	66.7	60
24	1920x1080 @60Hz DMT-RB	67.5	60
25	480P@60Hz	31.469	59.94
26	720P@60Hz	44.955	59.94
27	1080I@60Hz	33.716	59.94
28	1080P@60Hz	67.433	59.94
29	576P@50Hz	31.25	50
30	720P@50Hz	37.5	50
31	1080I@50Hz	28.125	50.08
32	1080P@50Hz	56.25	50
33	3840x2160@30	67.5	30
34	3840x2160@60	135	60

- The PC text quality is optimum in UHD mode (3840 x 2160, 60Hz).
- Your PC display screen might appear different depending on the manufacturer (and your particular version of Windows).
- Check your PC instruction book for information about connecting your PC to a display.
- If a vertical and horizontal frequency-select mode exists, select 60Hz (vertical) and 31.5KHz (horizontal). In some cases, abnormal signals (such as stripes) might appear on the screen when the PC power is turned off (or if the PC is disconnected). If so, press the [INPUT] button to enter the video mode. Also, make sure that the PC is connected.
- When horizontal synchronous signals seem irregular in RGB mode, check PC power saving mode or cable connections.
- The display settings table complies to the IBM/VESA standards, and based on the analog input.
- The DVI support mode is regarded as same to the PC support mode.
- The best timing for the vertical frequency to each mode is 60Hz.

9. Pixel Defect Policy

We strive to deliver the highest quality products and use some of the industry's most advanced manufacturing processes whilst practicing stringent quality control. However, pixel or sub-pixel defects on the PDP / TFT panels used in Plasma- & LCD- displays are sometimes unavoidable. No manufacturer can guarantee that all panels will be free from pixel defects, but Philips guarantees that any Plasma- & LCD- displays with an unacceptable number of defects will be repaired during the warranty period in line with your local guarantee conditions.

This notice explains the different types of pixel defects and defines the acceptable defect level for the LCD screen. In order to qualify for repair under warranty, the number of pixel defects must exceed a certain level as shown in the reference table. If the LCD screen is within specification a warranty exchange / claim back will be refused. Additionally, because some types or combinations of pixel defects are more noticeable than others, Philips sets even higher quality standards for those.

9.1. Pixels and Sub-Pixels

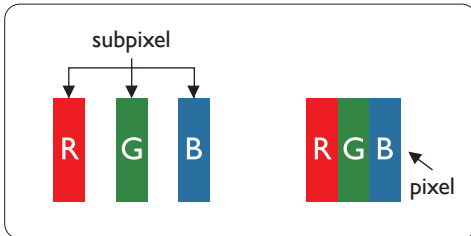

A pixel, or picture element, is composed of three sub-pixels in the primary colors of red, green and blue. Many pixels together form an image. When all sub-pixels of a pixel are lit, the three colored sub-pixels together appear as a single white pixel. When all are dark, the three colored sub-pixels together appear as a single black pixel. Other combinations of lit and dark sub-pixels appear as single pixels of other colors.

9.2. Types of Pixel Defects + Dot Definition

Pixel and sub-pixel defects appear on the screen in different ways. There are three categories of pixel defects and several types of sub-pixel defects within each category.

Dot definition = What is a defective "Dot"?:

One or more defective, adjacent sub-pixel are defined as one "dot". The no. of defective sub-pixels are not relevant to define a defective dot. This means that a defective dot can consist of one, two or three defective sub-pixels which can be dark or lit.

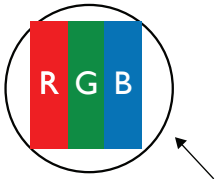

One dot = One Pixel; consists of three sub-pixels of Red, Green, and Blue.

9.3. Bright Dot Defects

Bright dot defects appear as pixels or sub-pixels that are always lit or "on". These are the examples of bright dot defects:

<p>One lit red, green or blue sub pixel</p>	<p>Two adjacent lit sub pixels: Red + Blue = Purple Red + Green = Yellow Green + Blue = Cyan (Light Blue)</p>	<p>Three adjacent lit sub pixels (one white pixel)</p>

9.4. Dark Dot Defects

Black dot defects appear as pixels or sub-pixels that are always dark or “off”. These are the examples of black dot defects:

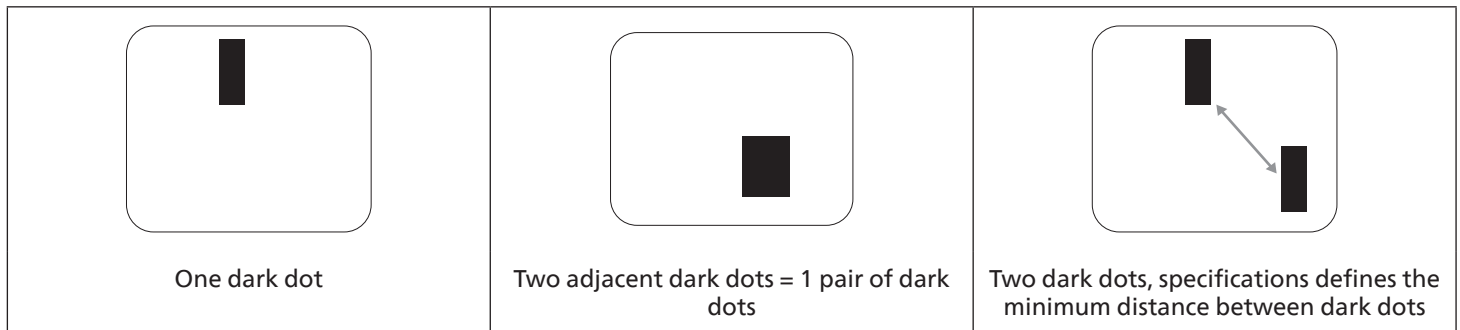

9.5. Proximity of Pixel Defects

Because pixel and sub-pixels defects of the same type that are nearby one another may be more noticeable, Philips also specifies tolerances for the proximity of pixel defects. In the table below you can find specifications about:

- Allowed amount of adjacent dark dots = (adjacent dark dots = 1 pair of dark dots)
- Minimum distance between dark dots
- Total no. of all defective dots

9.6. Pixel Defect Tolerances

In order to qualify for repair due to pixel defects during the warranty period, a PDP / TFT panel in a Philips Plasma / LCD- display must have pixel or sub-pixel defects exceeding the tolerances listed in the following table.

BRIGHT DOT EFFECT	ACCEPTABLE LEVEL
1 lit sub pixel	2
BLACK DOT EFFECT	ACCEPTABLE LEVEL
1 dark sub pixel	10
TOTAL DOT DEFECTS OF ALL TYPES	12

NOTE: * 1 or 2 adjacent sub pixel defects = 1 dot defect

9.7. Mura

Dark spots or patches may occasionally appear on some liquid crystal display (LCD) panels. This is known within the industry as Mura, which is a Japanese term for “unevenness.” It is used to describe an irregular pattern or area in which uneven screen uniformity appears under certain conditions. Mura is a result of the deterioration of the liquid crystal alignment layer and is most commonly caused by long-term operation under high ambient temperatures. It is an industry- wide phenomenon and Mura is not repairable. It is also not covered by our warranty terms.

Mura has been around since the introduction of LCD technology and with screens getting bigger and in operation 24/7, many displays are running in low light conditions. This all adds to the possibility of Mura affecting displays.

HOW TO SPOT MURA

There are many symptoms of Mura and also multiple causes. Several of these are listed below:

- Impurities or foreign particles in the crystal matrix
- Uneven distribution of LCD matrix during manufacturing
- Non-uniform luminance distribution of the backlight
- Panel assembly induced stress
- Flaws within the LCD cells
- Thermal induced stress - high temperature operation over long periods of time

HOW TO AVOID MURA

Although we can not guarantee the complete eradication of Mura every time, in general the appearance of Mura can be minimized by these methods:

- Lower the backlight brightness
- Use a screen saver
- Reduce the ambient temperature around the unit

10. Cleaning and Troubleshooting

10.1. Cleaning

Caution When Using the Display

- Do not bring your hands, face or objects close to the ventilation holes of the display. The top of the display is usually very hot due to the high temperature of exhaust air being released through the ventilation holes. Burns or personal injuries may occur if any body parts are brought too close. Placing any object near the top of the display could also result in heat related damage to the object as well as the display itself.
- Be sure to disconnect all cables before moving the display. Moving the display with its cables attached may damage the cables and thus cause fire or electric shock.
- Disconnect the power plug from the wall outlet as a safety precaution before carrying out any type of cleaning or maintenance procedure.

Front Panel Cleaning Instructions

- The front of the display has been specially treated. Wipe the surface gently using only a cleaning cloth or a soft, lint-free cloth.
- If the surface becomes dirty, soak a soft, lint-free cloth in a mild detergent solution. Wring the cloth to remove excess liquid. Wipe the surface of the display to remove dirt. Then use a dry cloth of the same type to dry.
- Do not scratch or hit the surface of the panel with fingers or hard objects of any kind.
- Do not use volatile substances such as insert sprays, solvents and thinners.

Cabinet Cleaning Instructions

- If the cabinet becomes dirty, wipe the cabinet with a soft, dry cloth.
- If the cabinet is extremely dirty, soak a lint-free cloth in a mild detergent solution. Wring the cloth to remove as much moisture as possible. Wipe the cabinet. Use another dry cloth to wipe over until the surface is dry.
- Do not use solution that contains oil to clean the plastic parts. Such product damage the plastic parts and void the warranty.
- Do not allow any water or detergent to come into contact with the surface of the display. If water or moisture gets inside the unit, operating problems, electrical and shock hazards may result.
- Do not scratch or hit the cabinet with fingers or hard objects of any kind.
- Do not use volatile substances such as insert sprays, solvents and thinners on the cabinet.
- Do not place anything made from rubber or PVC near the cabinet for any extended periods of time.

10.2. Troubleshooting

Symptom	Possible Cause	Remedy
No picture is displayed	<ol style="list-style-type: none"> 1. The power cord is disconnected. 2. The main power switch on the back of the display is not switched on. 3. The selected input has no connection. 4. The display is in standby mode. 	<ol style="list-style-type: none"> 1. Plug in the power cord. 2. Make sure the power switch is switched on. 3. Connect a signal connection to the display.
Interference displayed on the display or audible noise is heard	Caused by surrounding electrical appliances or fluorescent lights.	Move the display to another location to see if the interference is reduced.
Color is abnormal	The signal cable is not connected properly.	Make sure that the signal cable is attached firmly to the back of the display.
Picture is distorted with abnormal patterns	<ol style="list-style-type: none"> 1. The signal cable is not connected properly. 2. The input signal is beyond the capabilities of the display. 	<ol style="list-style-type: none"> 1. Make sure that the signal cable is attached firmly. 2. Check the video signal source to see if it is beyond the range of the display. Please verify its specifications with this display's specification section.
Display image doesn't fill up the full size of the screen	<ol style="list-style-type: none"> 1. The zoom mode is not set correctly. 2. Scan Mode may be set incorrectly to underscan. 3. If the image exceeds the screen size, Scan Mode may need to be set to Underscan. 	Use the Zoom mode or Custom zoom function in the Screen menu to fine tune display geometry and time frequency parameter.
Can hear sound, but no picture	Source signal cable is connected improperly.	Make sure that both video inputs and sound inputs are correctly connected.
Can see picture but no sound is heard	<ol style="list-style-type: none"> 1. Source signal cable is connected improperly. 2. Volume is turned all the way down. 3. {Mute} is turned on. 4. No external speaker connected. 	<ol style="list-style-type: none"> 1. Make sure that both video inputs and sound inputs are correctly connected. 2. Press [⊕] or [⊖] button to hear sound. 3. Switch MUTE off by using the [MUTE] button. 4. Connect external speakers and adjust the volume to a suitable level.
Some picture elements do not light up	Some pixels of the display are off.	This display is manufactured using an extremely high level of precision technology: however, sometimes some pixels of the display may not display. This is not a malfunction.
After-Images can still be seen on the display after the display is powered off. (Examples of still pictures include logos, video games, computer images, and images displayed in 4:3 normal mode)	A still picture is displayed for an over extended period of time	Do not allow a still image to be displayed for an extended period of time as this can cause a permanent after-image to remain on the display.

11. Technical Specifications

Display:

Item	Specifications		
	43BDL6017P	50BDL6017P	55BDL6017P
Screen Size (Active Area)	108 cm / 42.5 inch	125.7 cm / 49.5 inch	138.7 cm / 54.6 inch
Aspect Ratio	16:9	16:9	16:9
Number of pixels	3840 (H) x 2160 (V)	3840 (H) x 2160 (V)	3840 (H) x 2160 (V)
Pixel pitch	0.2451 (H) x 0.2451 (V) [mm]	0.2854 (H) x 0.2854 (V) [mm]	0.315 (H) x 0.315 (V) [mm]
Displayable colors	8 bits+FRC, 1.07 Billion colors	8 bits+FRC, 1.07 Billion colors	8 bits+FRC, 1.07 Billion colors
Brightness (typical)	700 cd/m ²	700 cd/m ²	700 cd/m ²
Contrast ratio (typical)	1200:1	4000:1	5000:1
Viewing angle	178 degrees	178 degrees	178 degrees

In/Out Terminals:

Item		Specifications
Speaker Output	Internal Speakers	10W (L) + 10W (R) [RMS]/8Ω 82 dB/W/M/160 Hz - 13 KHz
Audio Output	3.5mm phone jack x 1	0.5V [rms] (Normal) / 2 Channel (L+R)
Audio Input	3.5mm phone jack x 1	0.5V [rms] (Normal) / 2 Channel (L+R)
RS232	2.5mm Phone jack x 2	RS232 in/RS232 out
RJ-45	RJ-45 Jack x 1 (8 pin)	10/100 LAN Port
HDMI Input /Output	HDMI Jack x 3 (in) / x1(out) (Type A) (19 pin)	Digital RGB: TMDS (Video + Audio) MAX: Video - 720p, 1080p, 3840 x 2160/60 Hz Audio - 48 KHz/ 2 Channel (L+R) Supports LPCM only
Displayport in/out	Displayport Jack x 2 (20 pin)	Digital RGB: TMDS (Video + Audio) MAX: Video - 720p, 1080p, 3840 x 2160/60 Hz Audio - 48 KHz / 2 Channel (L+R) Supports LPCM only
DVI-I Input	DVI-I Jack	Digital RGB: TMDS (Video) Analog RGB: 0.7V [p-p] (75Ω), H/CS/V: TTL (2.2kΩ), MAX: 1920 x 1080/60 Hz (WUXGA)
IR Input/Output	3.5mm x 2	IR pass through
USB Input	USB x 2 (Type A)	USB 2.0, Multimedia play and service port

General:

Item	Specifications		
	43BDL6017P	50BDL6017P	55BDL6017P
Power Input	100 - 240V~, 50/60Hz	100 - 240V~, 50/60Hz	100 - 240V~, 50/60Hz
Power Consumption (Max)	152 W	171 W	204 W
Power Consumption (typ.)	85 W	104 W	142 W
Power Consumption (Standby mode & Off mode)	<0.5 W	<0.5 W	<0.5 W
AC Switch Off Mode (W)	0 W	0 W	0 W
Dimensions [W x H x D]	973 x 561.2 x 76.8 mm	1128.4 x 649 x 76.8 mm	1241.8 x 712.6 x 76.8mm
Weight	14.12 Kg	17.45 Kg	20.50 Kg
Gross Weight	18.00 Kg	22.17 Kg	27.16 Kg

Environmental Condition:

Item		Specifications
Temperature	Operational	0 ~ 40°C
	Storage	-20 ~ 60°C
Humidity	Operational	20 ~ 80% RH (No condensation)
	Storage	5 ~ 95% RH (No condensation)
Altitude	Operational	0 ~ 5,000 m
	Storage / Shipment	0 ~ 9,000 m

Warranty policy for Philips Professional Display Solutions

Thank you for purchasing this Philips product. Philips products are designed and manufactured with high standards and deliver high quality performance, ease of use and ease of installation. If you encounter any difficulties while using your product, we recommend that you first consult the user manual or the information in the support section of the website, where (depending on the product type) you may find a downloadable user manual, frequently asked questions, instruction videos or a support forum.

LIMITED WARRANTY

In the unlikely event the product requires service, we will arrange for your Philips product to be serviced free-of-charge within the warranty period, provided that the product was used in accordance with the user manual (e.g. in the intended environment).

For these product categories, a partner company of Philips is the warrantor of the product. Please check the documentation supplied with your product.

WHO IS COVERED?

Your Warranty coverage begins from the first date of purchase of the product. You need to provide proof of purchase to receive warranty service. A valid sales receipt or other valid document showing that you purchased the product is considered proof of purchase.

WHAT IS COVERED?

If any defect due to faulty materials and/or workmanship occurs within the warranty period, we will make arrangements for a free of charge service. Where a repair is not possible or not commercially viable, we may replace the product with a new or equivalent refurbished product with similar functionality. Replacement will be offered at our discretion and the warranty will continue from the date of original purchase of the first date of purchase of the product. Please note that all parts, including repaired and replaced parts, are covered only for the duration of the original warranty period.

WHAT IS EXCLUDED? Your warranty does not cover:

- Consequential damages (including but not limited to loss of data or loss of income), nor compensation for activities done by yourself, such as regular maintenance, installing firmware updates or saving or restoring data (Some states do not allow the exclusion of incidental or consequential damages, so the above exclusion may not apply to you. This includes, but is not limited to, prerecorded material, whether copyrighted or not copyrighted.)
- Labor charges for installation or setup of the product, adjustment of customer controls on the product, and installation or repair of various types of external devices (e.g., WiFi, antenna, USB dongles, OPS type devices) and other systems outside of the product.
- Reception problems caused by signal conditions or cable or antenna systems outside the unit.
- A product that requires modification or adaptation to enable it to operate in any country other than the country for which it was designed, manufactured, approved and/or authorized, or repair of products damaged by these modifications.
- If the model or production number on the product has been altered, deleted, removed or made illegible.

The warranty applies on condition that the product has been handled properly for its intended use and in accordance with the operating instructions

To Obtain Warranty Service And Information

For detailed warranty coverage information and additional support requirement and help line, please contact the seller and/or system integrator you purchased the product from. Please note in the USA, this limited warranty is only valid for Products purchased in the Continental United States, Alaska, and Hawaii.

Before Requesting Service

Please check your user's manual before requesting service. Adjustments of the controls discussed there may save you a service call.

WARRANTY PERIOD

Warranty period for PHILIPS signage display is listed as below, for areas not covered in this table, please follow their warranty statement.

Standard warranty period for PHILIPS signage display is listed as below, for areas not covered in this table, please follow the local warranty statement.

Region	Standard Warranty Period
USA, Canada	3 years
China	1 year
Japan	3 years
Rest of world	3 years
Mexico	3 years
Brazil	3 years
Chile	3 years
Peru	3 years

Note that for professional products, the specific warranty terms of the sale- or purchase agreement may apply.

Index

A

AC Switch Cover 19

C

Cleaning and Troubleshooting 37

Connecting a PC 20

Connecting External Equipment 20

Connecting Multiple Displays in a Daisy-chain
Configuration 21

Control Panel 14

I

Input Mode 33

Input/Output Terminals 15

Installation Notes 10

IR connection 21

IR Pass-through Connection 22

M

Mounting in Portrait Orientation 12

Mounting on a Wall 11

N

Navigating the OSD Menu 24

O

Operating Instructions of Edge Alignment Kit 13

Operation 23

OSD Menu 24

OSD Menu Overview 24

P

Package Contents 10

Parts and Functions 14

Pixel Defect Policy 34

Play multimedia files from USB device 23

R

Remote Control 16

S

Safety Instructions 1

Supported Media Formats 32

T

Technical Specifications 39

U

Unpacking 8

Unpacking and Installation 8

USB Cover 19

W

Warranty policy for Philips Professional Display Solutions
41

Wire-Connecting to Network 22



2025 © TOP Victory Investments Ltd. All rights reserved.

This product has been manufactured by and is sold under the responsibility of Top Victory Investments Ltd., and Top Victory Investments Ltd. is the warrantor in relation to this product. Philips and the Philips Shield Emblem are registered trademarks of Koninklijke Philips N.V. and are used under license.

Specifications are subject to change without notice.
Version: V1.00 2025-03-19